

# Blu-ray Disc<sup>™</sup>/ DVD Home Theatre System

Operating Instructions

## WARNING

Do not install the appliance in a confined space, such as a bookcase or built-in cabinet.

To reduce the risk of fire, do not cover the ventilation opening of the apparatus with newspapers, tablecloths, curtains, etc. Do not place the naked flame sources such as lighted candles on the apparatus. Do not expose batteries or apparatus with battery-installed to excessive heat such as sunshine, fire or the like.

To prevent injury, this apparatus must be securely attached to the floor/wall in accordance with the installation instructions.

Indoor use only.

## CAUTION

The use of optical instruments with this product will increase eye hazard. As the laser beam used in this Blu-ray Disc / DVD Home Theatre System is harmful to eyes, do not attempt to disassemble the cabinet.

Refer servicing to qualified personnel only.

CAUTION	CLASS 3R VISIBLE AND INVISIBLE LASER RADIATION WHEN OPEN. AVOID DIRECT EYE EXPOSURE.
VORSICHT	KLASSE 3R SICHTBARE UND UNSICHTBARE LASERSTRAHLUNG WENN GEÖFFNET. UNMITTELBARER AUGENKONTAKT VERMEIDEN.
ADVARSEL	SYNLIG OG USYNLIG LASERSTRÅLING AF KLASSE 3R VED ÅBNING. UNDGÅ AT SE DIREKTE PÅ STRÅLEN.
ADVARSEL	SYNLIG OG USYNLIG LASERSTRÅLING KLASSE 3R NÄR DENNEN ÅPNET. UNNGÅ DIREKTE EXPOSERING AV ÖGONENE.
VARNING	KLASS 3R SYNLIG OCH USYNLIG LASERSTRÅLING NÄR DENNA DEL ÄR ÖPPNAD. UNDVIK ATT DIREKT EXPONERAS ÖGONEN FÖR STRÅLNINGEN.
VARO!	AVATTUNA LUOKAN 3R NÄKYVÄÄ JA NÄKYMÄTÖNTÄ LASERSÄTELYÄ. VÄLTÄ KATSEEN SUORAAN AILTIKASTAMISTA.
警告	打开时有3类可见和不可见激光辐射。避免眼睛受到直射的照射
注意	打開時有第3類可視及不可視雷射輻射。避免眼睛直接暴露。

This appliance is classified as a CLASS 3R LASER product. Visible and invisible laser radiation is emitted when the laser protective housing is opened, so be sure to avoid direct eye exposure. This marking is located on the laser protective housing inside the enclosure.

CLASS 1 LASER PRODUCT  
LASER KLASSE 1  
LUOKAN 1 LASERLAITE  
KLASS 1 LASERAPPARAT

1类激光产品  
第1类雷射产品

This appliance is classified as a CLASS 1 LASER product. This marking is located on the rear exterior.

## To reduce the risk of fire or electric shock, do not expose this apparatus to rain or moisture.

These following indications are located on the bottom exterior.



This symbol is intended to alert the user to the presence of uninsulated "dangerous voltage" within the product's enclosure that may be of sufficient magnitude to constitute a risk of electric shock to persons.



This symbol is intended to alert the user to the presence of important operating and maintenance (servicing) instructions in the literature accompanying the appliance.

## Owner's Record

The model and serial numbers are located on the bottom exterior of the unit. Record these numbers in the space provided below. Refer to them whenever you call upon your Sony dealer regarding this product.

Model No. BDV-N790W/BDV-T79

Serial No. \_\_\_\_\_

The following FCC statement applies only to the version of this

model manufactured for sale in the U.S.A. Other versions may not comply with FCC technical regulations.

## NOTE:

This equipment has been tested and found to comply with the limits for a Class B digital device, pursuant to Part 15 of the FCC Rules. These limits are designed to provide reasonable protection against harmful interference in a residential installation. This equipment generates, uses, and can radiate radio frequency energy and, if not installed and used in accordance with the instructions, may cause harmful interference to radio communications. However, there is no guarantee that interference will not occur in a particular installation. If this equipment does cause harmful interference to radio or television reception, which can be determined by turning the equipment off and on, the user is encouraged to try to correct the interference by one or more of the following measures:

- Reorient or relocate the receiving antenna (aerial).
- Increase the separation between the equipment and receiver.
- Connect the equipment into an outlet on a circuit different from that to which the receiver is connected.
- Consult the dealer or an experienced radio/TV technician for help.

## CAUTION

You are cautioned that any changes or modifications not expressly approved in this manual could void your authority to operate this equipment.

Properly shielded and grounded cables and connectors must be used for connection to host computers and/or peripherals in order to meet FCC emission limits.

## Important Safety Instructions

- 1) Read these instructions.
- 2) Keep these instructions.
- 3) Heed all warnings.
- 4) Follow all instructions.
- 5) Do not use this apparatus near water.
- 6) Clean only with dry cloth.
- 7) Do not block any ventilation openings. Install in accordance with the manufacturer's instructions.
- 8) Do not install near any heat sources such as radiators, heat registers, stoves, or other apparatus (including amplifiers) that produce heat.
- 9) Do not defeat the safety purpose of the polarized or grounding-type plug. A polarized plug has two blades with one wider than the other. A grounding type plug has two blades and a third grounding prong. The wide blade or the third prong are provided for your safety. If the provided plug does not fit into your outlet, consult an electrician for replacement of the obsolete outlet.
- 10) Protect the power cord from being walked on or pinched particularly at plugs, convenience receptacles, and the point where they exit from the apparatus.
- 11) Only use attachments/accessories specified by the manufacturer.
- 12) Use only with the cart, stand, tripod, bracket, or table specified by the manufacturer, or sold with the apparatus. When a cart is used, use caution when moving the cart/apparatus combination to avoid injury from tip-over.



- 13) Unplug this apparatus during lightning storms or when unused for long periods of time.
- 14) Refer all servicing to qualified service personnel. Servicing is required when the apparatus has been damaged in any way, such as power-supply cord or plug is damaged, liquid has been spilled or objects have fallen into the apparatus, the apparatus has been exposed to rain or moisture, does not operate normally, or has been dropped.

### For the main unit

The nameplate and the date of manufacture marking are located on the bottom exterior.

### Precautions

#### On power sources

- The unit is not disconnected from the mains as long as it is connected to the AC outlet, even if the unit itself has been turned off.
- As the main plug is used to disconnect the unit from the mains, connect the unit to an easily accessible AC outlet. Should you notice an abnormality in the unit, disconnect the main plug from the AC outlet immediately.

### On watching 3D video images

Some people may experience discomfort (such as eye strain, fatigue, or nausea) while watching 3D video images. Sony recommends that all viewers take regular breaks while watching 3D video images. The length and frequency of necessary breaks will vary from person to person. You must decide what works best. If you experience any discomfort, you should stop watching the 3D video images until the discomfort ends; consult a doctor if you believe necessary. You should also review

(i) the instruction manual and/or the caution message of any other device used with, or Blu-ray Disc contents played with this product and (ii) our website (<http://esupport.sony.com/>) for the latest information. The vision of young children (especially those under six years old) is still under development. Consult your doctor (such as a pediatrician or eye doctor) before allowing young children to watch 3D video images. Adults should supervise young children to ensure they follow the recommendations listed above.

### Blu-ray Disc/DVD receiver (HBD-N790W/HBD-T79)

This equipment must not be co-located or operated in conjunction with any other antenna or transmitter.

This equipment complies with FCC radiation exposure limits set forth for an uncontrolled environment and meets the FCC radio frequency (RF) Exposure Guidelines in Supplement C to OET65.

This equipment should be installed and operated keeping the radiator at least 20cm or more away from person's body (excluding extremities: hands, wrists, feet and ankles).

### For the wireless transceiver (EZW-RT50)

This device complies with part 15 of the FCC rules. Operation is subject to the following two conditions: (1) this device may not cause harmful interference, and (2) this device must accept any interference received, including interference that may cause undesired operation.

This equipment must not be co-located or operated in conjunction

with any other antenna or transmitter.

This equipment complies with FCC radiation exposure limits set forth for an uncontrolled environment and meets the FCC radio frequency (RF) Exposure Guidelines in Supplement C to OET65.

This equipment should be installed and operated keeping the radiator at least 20cm or more away from person's body (excluding extremities: hands, wrists, feet and ankles).

## Copy Protection

- Please be advised of the advanced content protection systems used in both Blu-ray Disc and DVD media. These systems, called AACs (Advanced Access Content System) and CSS (Content Scramble System), may contain some restrictions on playback, analog output, and other similar features. The operation of this product and the restrictions placed may vary depending on the date of purchase, as the governing board of the AACs may adopt or change its restriction rules after the time of purchase.
- Cinavia Notice  
This product uses Cinavia technology to limit the use of unauthorized copies of some commercially-produced film and videos and their soundtracks. When a prohibited use of an unauthorized copy is detected, a message will be displayed and playback or copying will be interrupted.  
More information about Cinavia technology is provided at the Cinavia Online Consumer Information Center at <http://www.cinavia.com>. To request additional information about Cinavia by mail, send a postcard with your mailing address to:  
Cinavia Consumer Information

Center, P.O. Box 86851, San Diego, CA, 92138, USA.

## Copyrights and Trademarks

- This system incorporates with Dolby® Digital and Dolby Pro Logic adaptive matrix surround decoder and the DTS® Digital Surround System.
  - \* Manufactured under license from Dolby Laboratories. Dolby, Pro Logic, and the double-D symbol are trademarks of Dolby Laboratories.
  - \*\* Manufactured under license under U.S. Patent Nos: 5,956,674; 5,974,380; 6,226,616; 6,487,535; 7,212,872; 7,333,929; 7,392,195; 7,272,567 & other U.S. and worldwide patents issued & pending. DTS-HD, the Symbol, & DTS-HD and the Symbol together are registered trademarks of DTS, Inc. Product includes software. © DTS, Inc. All Rights Reserved.
- This system incorporates High-Definition Multimedia Interface (HDMI™) technology. HDMI, the HDMI logo and High-Definition Multimedia Interface are trademarks or registered trademarks of HDMI Licensing LLC in the United States and other countries.
- Java is a trademark of Oracle and/or its affiliates.
- “BD-LIVE” and “BONUSVIEW” are trademarks of Blu-ray Disc Association.
- “Blu-ray Disc” is a trademark.
- “Blu-ray Disc,” “DVD+RW,” “DVD-RW,” “DVD+R,” “DVD-R,” “DVD VIDEO,” and “CD” logos are trademarks.
- “Blu-ray 3D” and “Blu-ray 3D” logo are trademarks of Blu-ray Disc Association.

- “BRAVIA” is a trademark of Sony Corporation.
- “AVCHD” and the “AVCHD” logo are trademarks of Panasonic Corporation and Sony Corporation.
- “XMB,” and “xross media bar” are trademarks of Sony Corporation and Sony Computer Entertainment Inc.
- “PlayStation” is a registered trademark of Sony Computer Entertainment Inc.
- Music and video recognition technology and related data are provided by Gracenote®. Gracenote is the industry standard in music recognition technology and related content delivery. For more information, please visit [www.gracenote.com](http://www.gracenote.com). CD, DVD, Blu-ray Disc, and music and video-related data from Gracenote, Inc., copyright © 2000-present Gracenote. Gracenote Software, copyright © 2000-present Gracenote. One or more patents owned by Gracenote apply to this product and service. See the Gracenote website for a nonexhaustive list of applicable Gracenote patents. Gracenote, CDDB, MusicID, MediaVOCS, the Gracenote logo and logotype, and the “Powered by Gracenote” logo are either registered trademarks or trademarks of Gracenote in the United States and/or other countries.



- Wi-Fi®, Wi-Fi Protected Access® and Wi-Fi Alliance® are registered marks of the Wi-Fi Alliance.
- Wi-Fi CERTIFIED™, WPA™, WPA2™ and Wi-Fi Protected Setup™ are marks of the Wi-Fi Alliance.
- The Wi-Fi CERTIFIED Logo is a certification mark of the Wi-Fi Alliance.

- The Wi-Fi Protected Setup Mark is a mark of the Wi-Fi Alliance.
- “PhotoTV HD” and the “PhotoTV HD” logo are trademarks of Sony Corporation.
- MPEG Layer-3 audio coding technology and patents licensed from Fraunhofer IIS and Thomson.
- This product incorporates proprietary technology under license from Verance Corporation and is protected by U.S. Patent 7,369,677 and other U.S. and worldwide patents issued and pending as well as copyright and trade secret protection for certain aspects of such technology. Cinavia is a trademark of Verance Corporation. Copyright 2004-2010 Verance Corporation. All rights reserved by Verance. Reverse engineering or disassembly is prohibited.
- iPhone, iPod, iPod classic, iPod nano, and iPod touch are trademarks of Apple Inc., registered in the U.S. and other countries.



- “Made for iPod,” and “Made for iPhone” mean that an electronic accessory has been designed to connect specifically to iPod or iPhone, respectively, and has been certified by the developer to meet Apple performance standards. Apple is not responsible for the operation of this device or its compliance with safety and regulatory standards. Please note that the use of this accessory with iPod or iPhone may affect wireless performance.
- Windows Media is either a registered trademark or trademark of Microsoft Corporation in the United States and/or other countries. This product contains technology subject to certain intellectual

property rights of Microsoft. Use or distribution of this technology outside of this product is prohibited without the appropriate license(s) from Microsoft.

Content owners use Microsoft® PlayReady™ content access technology to protect their intellectual property, including copyrighted content. This device uses PlayReady technology to access PlayReady-protected content and/or WMDRM-protected content. If the device fails to properly enforce restrictions on content usage, content owners may require Microsoft to revoke the device’s ability to consume PlayReady-protected content. Revocation should not affect unprotected content or content protected by other content access technologies. Content owners may require you to upgrade PlayReady to access their content. If you decline an upgrade, you will not be able to access content that requires the upgrade.

- DLNA®, the DLNA Logo and DLNA CERTIFIED™ are trademarks, service marks, or certification marks of the Digital Living Network Alliance.
- Opera® Browser from Opera Software ASA. Copyright 1995-2010 Opera Software ASA. All rights reserved.



- All other trademarks are trademarks of their respective owners.
- Other system and product names are generally trademarks or registered trademarks of the manufacturers.™ and ® marks are not indicated in this document.

## End User License Information

### Gracenote® End User License Agreement

This application or device contains software from Gracenote, Inc. of Emeryville, California (“Gracenote”). The software from Gracenote (the “Gracenote Software”) enables this application to perform disc and/or file identification and obtain music-related information, including name, artist, track, and title information (“Gracenote Data”) from online servers or embedded databases (collectively, “Gracenote Servers”) and to perform other functions. You may use Gracenote Data only by means of the intended End-User functions of this application or device.

You agree that you will use Gracenote Data, the Gracenote Software, and Gracenote Servers for your own personal non-commercial use only. You agree not to assign, copy, transfer or transmit the Gracenote Software or any Gracenote Data to any third party. YOU AGREE NOT TO USE OR EXPLOIT GRACENOTE DATA, THE GRACENOTE SOFTWARE, OR GRACENOTE SERVERS, EXCEPT AS EXPRESSLY PERMITTED HEREIN.

You agree that your non-exclusive license to use the Gracenote Data, the Gracenote Software, and Gracenote Servers will terminate if you violate these restrictions. If your license terminates, you agree to cease any and all use of the Gracenote Data, the Gracenote Software, and Gracenote Servers. Gracenote reserves all rights in Gracenote Data, the Gracenote Software, and the Gracenote Servers, including all ownership rights. Under no circumstances will Gracenote become liable for any payment to you for any information that you provide. You agree that Gracenote, Inc. may enforce its

rights under this Agreement against you directly in its own name.

The Gracenote service uses a unique identifier to track queries for statistical purposes. The purpose of a randomly assigned numeric identifier is to allow the Gracenote service to count queries without knowing anything about who you are. For more information, see the web page for the Gracenote Privacy Policy for the Gracenote service.

The Gracenote Software and each item of Gracenote Data are licensed to you “AS IS.” Gracenote makes no representations or warranties, express or implied, regarding the accuracy of any Gracenote Data from in the Gracenote Servers. Gracenote reserves the right to delete data from the Gracenote Servers or to change data categories for any cause that Gracenote deems sufficient. No warranty is made that the Gracenote Software or Gracenote Servers are error-free or that functioning of Gracenote Software or Gracenote Servers will be uninterrupted. Gracenote is not obligated to provide you with new enhanced or additional data types or categories that Gracenote may provide in the future and is free to discontinue its services at any time. GRACENOTE DISCLAIMS ALL WARRANTIES EXPRESS OR IMPLIED, INCLUDING, BUT NOT LIMITED TO, IMPLIED WARRANTIES OF MERCHANTABILITY, FITNESS FOR A PARTICULAR PURPOSE, TITLE, AND NON-INFRINGEMENT. GRACENOTE DOES NOT WARRANT THE RESULTS THAT WILL BE OBTAINED BY YOUR USE OF THE GRACENOTE SOFTWARE OR ANY GRACENOTE SERVER. IN NO CASE WILL GRACENOTE BE LIABLE FOR ANY CONSEQUENTIAL OR INCIDENTAL DAMAGES OR FOR ANY LOST PROFITS OR LOST REVENUES.

© Gracenote, Inc. 2009

---

## About These Operating Instructions

- The instructions in these Operating Instructions describe the controls on the remote. You can also use the controls on the unit if they have the same or similar names as those on the remote.
- In this manual, “disc” is used as a general reference for BDs, DVDs, Super Audio CDs, or CDs unless otherwise specified by the text or illustrations.
- The instructions in this manual are for BDV-N790W and BDV-T79. BDV-N790W is the model used for illustration purposes. Any difference in operation is clearly indicated in the text, for example, “BDV-N790W only.”
- Some illustrations are presented as conceptual drawings, and may be different from the actual products.
- The items displayed on the TV screen may vary depending on the area.
- The default setting is underlined.

# Table of Contents

About These Operating Instructions .....	6
Unpacking .....	8
Index to Parts and Controls.....	9

## Getting Started

<b>Step 1: Installing the System.....</b>	<b>14</b>
<b>Step 2: Connecting the System... 14</b>	
<b>Connecting the speakers .....</b>	<b>14</b>
<b>Connecting the TV .....</b>	<b>16</b>
<b>Connecting the other components</b>	
<b>(Set-top box, etc.) .....</b>	<b>17</b>
<b>Connecting the antenna</b>	
<b>(aerial) .....</b>	<b>19</b>
<b>Step 3: Preparing for Network</b>	
<b>Connection .....</b>	<b>19</b>
<b>Step 4: Setting up the</b>	
<b>Wireless System .....</b>	<b>20</b>
<b>Step 5: Performing the Easy</b>	
<b>Setup.....</b>	<b>22</b>
<b>Step 6: Selecting the Source .....</b>	<b>23</b>
<b>Step 7: Enjoying Surround</b>	
<b>Sound.....</b>	<b>23</b>

## Playback

Playing a Disc .....	25
Playing from a USB Device.....	26
Enjoying an iPod/iPhone.....	27
Playing via a Network.....	28
Available Options .....	30

## Sound Adjustment

Selecting the Audio Format, Multilingual	
Tracks, or Channel.....	33
Enjoying Multiplex Broadcast	
Sound .....	33

## Tuner

Listening to the Radio .....	34
------------------------------	----

## Other Operations

Using the Control for HDMI Function for	
“BRAVIA” Sync .....	35
Calibrating the Appropriate Speaker	
Settings Automatically .....	35
Setting the Speakers .....	36
Using the Sleep Timer .....	37

Deactivating the Buttons on	
the Unit.....	38
Controlling Your TV with the Supplied	
Remote .....	38
Changing the Brightness of the Front	
Panel Display and Power	
Indicator .....	38
Saving Power in Standby Mode .....	38
Browsing Websites .....	39
Further Settings for the Wireless	
System .....	40

## Settings and Adjustments

Using the Setup Display .....	42
[Network Update].....	42
[Screen Settings].....	43
[Audio Settings].....	44
[BD/DVD Viewing Settings].....	45
[Parental Control Settings] .....	45
[Music Settings].....	46
[System Settings].....	46
[External Input Settings].....	47
[Network Settings].....	47
[Easy Setup].....	48
[Resetting] .....	48

## Additional Information

Precautions.....	49
Notes about Discs .....	50
Troubleshooting.....	51
Playable Discs.....	55
Playable Types of Files.....	56
Supported Audio Formats.....	57
Specifications.....	58
Language Code List.....	60
Index .....	61

# Unpacking

- Front speakers (2)

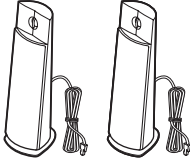

- Surround speakers (2)

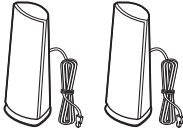

- Center speaker (1)

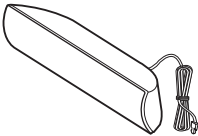

- Subwoofer (1)

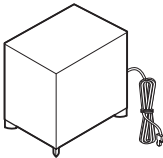

- FM wire antenna (aerial) (1)

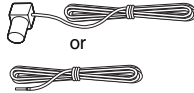

- Remote commander (remote) (1)

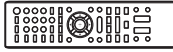

- R6 (size AA) batteries (2)



- Calibration mic (1)

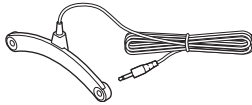

- Dock for iPod/iPhone (TDM-iP30) (1)

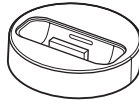

- USB cable (1)



- Video cord (1)



- High Speed HDMI cable (1) (BDV -T79 only)

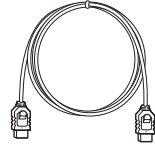

- Surround amplifier (1)

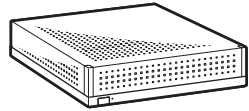

- Wireless transceivers (2)



- Operating Instructions
- Quick Setup Guide
- Speaker Installation Guide



# Index to Parts and Controls

For more information, refer to the pages indicated in parentheses.

## Front panel

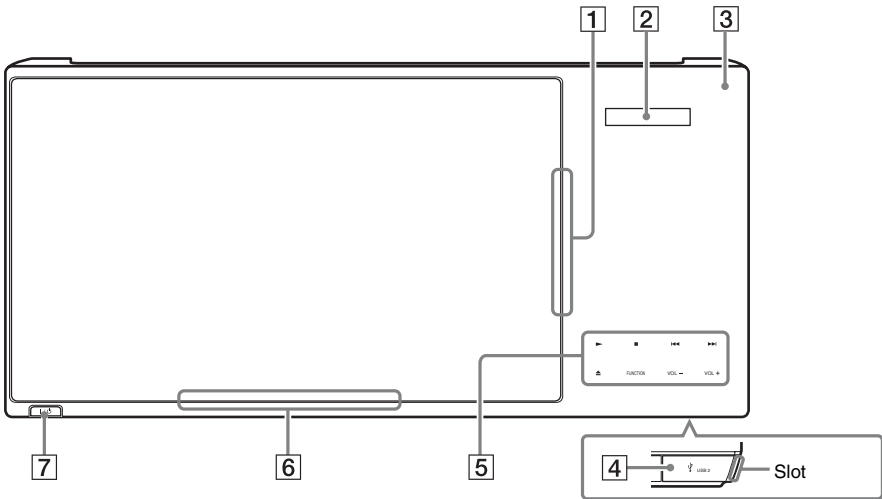

- 1 Disc slot (page 25)**
- 2 Front panel display**
- 3 (remote sensor)**
- 4 USB 2 port (page 26)**  
Open the cover using a fingernail in the slot.
- 5 Soft-touch buttons/indicators**
  - (play)
  - (stop)
  - (previous/next)
  - (eject)
- FUNCTION (page 23)**  
Selects the playback source.
- VOL +/-**
- 6 Power indicator**  
Lights up while the system is turned on.
- 7 (on/standby)**  
Turns on the unit, or sets it to standby mode.

### About soft-touch buttons/indicators

These buttons function when the soft-touch button indicators are lit.

You can turn on/off the indicators by setting [Illumination/Display] (page 46). When you set [Illumination/Display] to [Auto], the indicators turn off. In this case, touch any soft-touch button. When the indicators light up, touch the desired button.

#### Note

- These buttons work when you touch them lightly. Do not press on them with excessive force.

## Front panel display

### About the indications in the front panel display

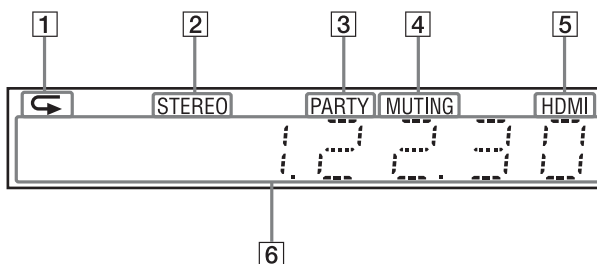

- 1** Lights up when repeat play is activated.
- 2** Lights up when stereo sound is received. (Radio only)
- 3** Lights up when the system is playing via the PARTY STREAMING function.
- 4** Lights up when muting is on.
- 5** Lights up when the HDMI (OUT) jack is correctly connected to an HDCP (High-bandwidth Digital Content Protection) compliant device with HDMI or DVI (Digital Visual Interface) input.
- 6** Displays the system's status, such as radio frequency, etc.  
When you press DISPLAY, the stream information/decoding status is displayed when the function is set to "TV."  
The stream information/decoding status may not appear depending on the stream or item being decoded.

## Rear panel

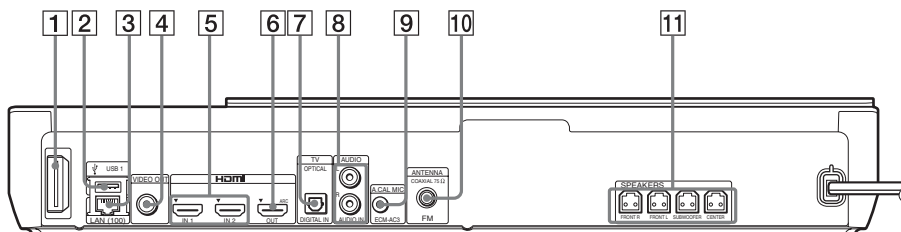

- 1** Wireless transceiver slot (page 20)
- 2** USB 1 port (page 26)
- 3** LAN (100) terminal (page 19)
- 4** VIDEO OUT jack (page 16)
- 5** HDMI (IN 1/IN 2) jacks (page 17)
- 6** HDMI (OUT) jack (page 16)
- 7** TV (DIGITAL IN OPTICAL) jack (page 16)
- 8** AUDIO (AUDIO IN L/R) jacks (page 17)
- 9** A.CAL MIC jack (pages 22, 35)
- 10** ANTENNA (FM COAXIAL 75Ω) jack (page 19)
- 11** SPEAKERS jacks (page 14)

# Surround amplifier

## Front panel

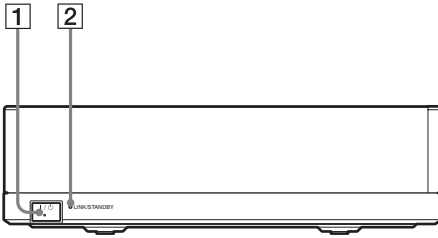

- 1 I/O (Power)
- 2 LINK/STANDBY indicator (page 21)  
You can check the status of wireless transmission between the main unit and surround amplifier.

## Rear panel

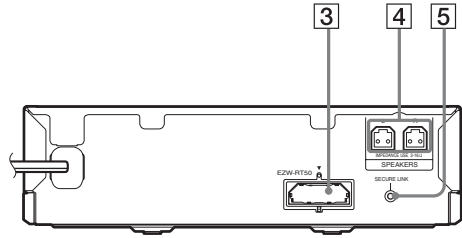

- 3 Wireless transceiver (EZW-RT50) slot
- 4 SPEAKERS jacks
- 5 SECURE LINK button (page 40)  
Starts the Secure Link function.

## Remote control

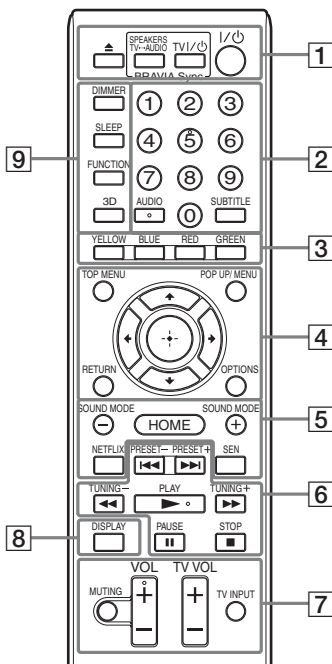

Number 5, AUDIO, VOL +, and ► buttons have a tactile dot. Use the tactile dot as a reference when operating the remote.

- **TV** : For TV operations  
(For details, see “Controlling Your TV with the Supplied Remote” (page 38).)

### The system automatically returns to standby mode

If any button on the unit or remote is not pressed within 30 minutes, the system automatically returns to standby mode.

#### 1 ▲ (eject)

##### **SPEAKERS TV↔AUDIO**

Selects whether TV sound is output from the system’s speakers or the TV’s speaker(s). This function works only when you set [Control for HDMI] to [On] (page 46).

##### **TV I/O (on/standby) (page 38)** **TV**

Turns on the TV or sets it to standby mode.

##### **I/O (on/standby) (pages 22, 34)**

Turns on the system or sets it to standby mode.

#### 2 **Number buttons (pages 34, 38)**

Enters the title/chapter numbers, preset station number, etc.

##### **AUDIO (page 33)**

Selects the audio format/track.

##### **SUBTITLE**

Selects the subtitle language when multilingual subtitles are recorded on a BD-ROM/DVD VIDEO.

#### 3 **Color buttons (yellow/blue/red/green)**

Short cut keys for selecting items on some BD menus (can also be used for Java interactive operations on BDs).

#### 4 **TOP MENU**

Opens or closes the BD’s or DVD’s Top Menu.

##### **POP UP/MENU**

Opens or closes the BD-ROM’s Pop-up Menu, or the DVD’s menu.

##### **OPTIONS (pages 23, 30, 39)**

Displays the options menu on the TV screen or in the front panel display. (The location differs based on the selected function.)

##### **RETURN**

Returns to the previous display.

##### **←/↑/↓/→**

Moves the highlight to a displayed item.

##### **⊕ (enter)**

Enters the selected item.

**5 SOUND MODE +/- (page 23)**

Selects the sound mode.

**HOME (pages 22, 34, 35, 36, 39, 40, 42)**

Enters or exits the system's home menu.

**NETFLIX**

Accesses the "NETFLIX" online service.

**SEN**

Accesses the "Sony Entertainment Network™" online service.

**6 Playback operation buttons**

See "Playback" (page 25).

**◀◀/▶▶ (previous/next)**

Skip to the previous/next chapter, track, or file.

**◀◀/▶▶ (fast/slow/freeze frame)**

Fast reverse/fast forward the disc during playback. Each time you press the button, the search speed changes.

Activates slow-motion play when pressed for more than one second in pause mode.

Plays one frame at a time when pressed in pause mode.

**Note**

- During Blu-ray 3D Disc playback, slow-motion reverse play and single-frame reverse play are not available.

**▶ (play)**

Starts or re-starts playback (resume play).

Activates One-Touch Play (page 35) when the system is on and set to the "BD/DVD" function.

**|| (pause)**

Pauses or re-starts playback.

**■ (stop)**

Stops playback and remembers the stop point (resume point). The resume point for a title/track is the last point you played or the last photo for a photo folder.

**Radio operation buttons**

See "Tuner" (page 34).

**PRESET +/-**

**TUNING +/-**

**7 MUTING**

Turns off the sound temporarily.

**VOL +/- (page 34)**

Adjusts the volume.

**TV VOL +/-**

Adjusts the TV volume.

**TV INPUT**

Switches the TV's input source between the TV and other input sources.

**8 DISPLAY (pages 25, 28, 39)**

Displays playback and web browsing information on the TV screen.

Displays the preset radio station, frequency, etc., in the front panel display.

**9 DIMMER**

Sets the brightness of the front panel display and power indicator to either of 2 levels.

**SLEEP (page 37)**

Sets the sleep timer.

**FUNCTION (pages 23, 34)**

Selects the playback source.

By setting [External Input Settings] (page 47), you can skip unused inputs when selecting a function.

**3D**

Converts 2D content into simulated 3D content when connected to a 3D compatible device.

## Getting Started

## Step 1: Installing the System

### How to position the system

Install the system by referring to the illustration below.

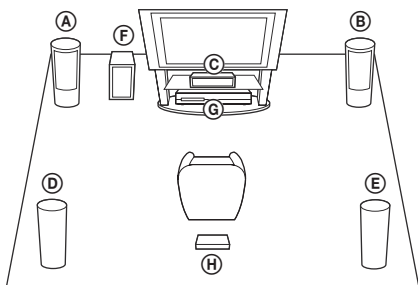

- Ⓐ Front speaker (L (left))
- Ⓑ Front speaker (R (right))
- Ⓒ Center speaker
- Ⓓ Surround speaker (L (left))
- Ⓔ Surround speaker (R (right))
- Ⓕ Subwoofer
- Ⓖ Unit
- Ⓗ Surround amplifier

#### Note

- Use caution when placing the speakers and/or speaker stands attached to the speakers on a specially treated (waxed, oiled, polished, etc.) floor, as staining or discoloration may result.
- Do not lean or hang on a speaker, as it may fall down.
- The speaker of this set is not anti-magnetic. This may result in color unevenness when it is placed near a CRT TV or projector.

#### Tip

- You can install the speakers on a wall. For details, refer to the supplied "Speaker Installation Guide."

## Step 2: Connecting the System

Do not connect the AC power cords (mains leads) of the unit and surround amplifier to a wall outlet (mains) until all the other connections are made.

#### Note

- When you connect another component with a volume control, turn down the volume of the other components to a level where sound is not distorted.

### Connecting the speakers

Connect the speaker cords to match the color of the SPEAKERS jacks of the unit.

When connecting to the unit, insert the connector until it clicks.

#### To the unit

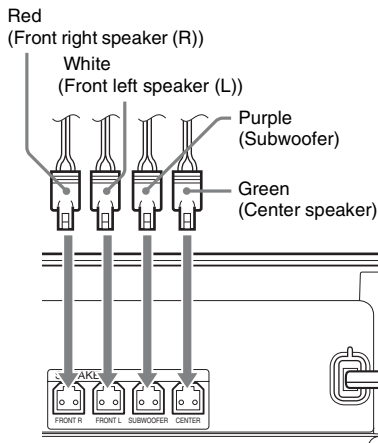

**To the surround amplifier**

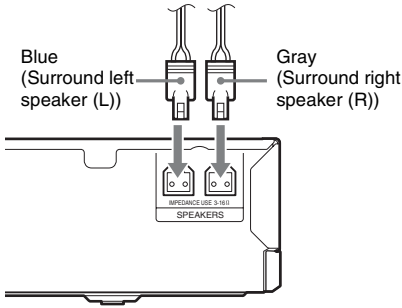





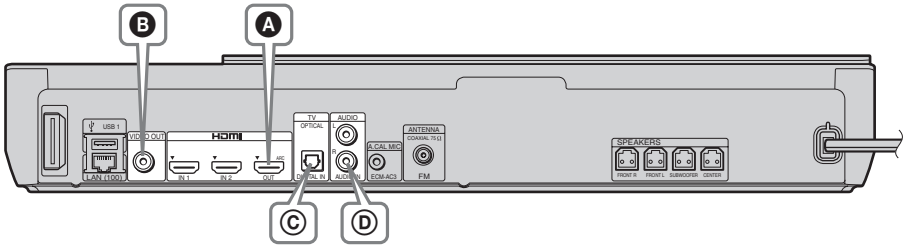

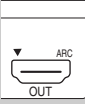

## Connecting the TV

Select one of the following connection methods according to the input jacks on your TV.

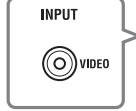

### Video connections

<p><b>A</b></p> 	<p>HDMI cable<sup>1)</sup> (supplied with BDV-T79 only)</p> 	<p>High quality</p>  
<p><b>B</b></p> 	<p>Video cord (not supplied<sup>3)</sup>)</p> 	<p>Standard quality</p>  







<sup>1)</sup> High Speed HDMI cable

<sup>2)</sup> If the HDMI IN jack of your TV is compatible with the ARC (Audio Return Channel) function, an HDMI cable connection can also send a digital audio signal from the TV. For setting the Audio Return Channel function, see [Audio Return Channel] (page 46).

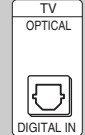
<sup>3)</sup> The supplied video cord is for connection of the Dock for iPod/iPhone.

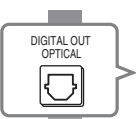
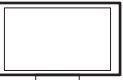
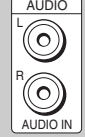
### Audio connections

If you do not connect the system to the TV's HDMI jack that is compatible with the ARC function, make an appropriate audio connection for listening to TV sound via the system's speakers.

<p><b>C</b></p> 	<p>Digital optical cord (not supplied)</p> 	<p>High quality</p>  
<p><b>D</b></p> 	<p>Audio cable (not supplied)</p> 	<p>Standard quality</p>  



## Connecting the other components (Set-top box, etc.)

Connect the system, other components, and TV as follows.

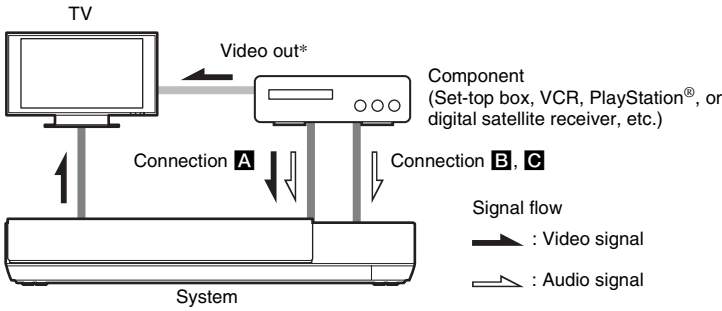

\* This connection is unnecessary for connection **A** (HDMI connection).

Select one of the following connection methods according to the jack type of the component.

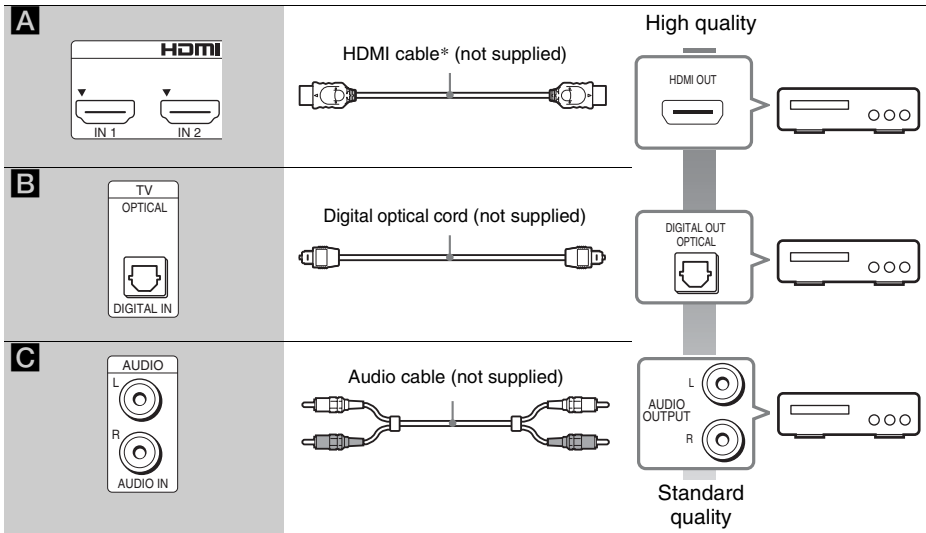
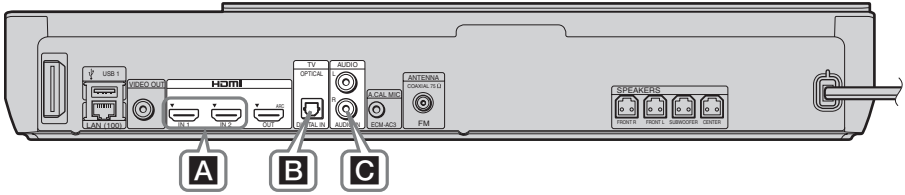

\* Use a High Speed HDMI cable.

## When you make connection **A**

This connection can send both video and audio signals.

### Note

- Video signals from the HDMI (IN 1/2) jacks are sent to the HDMI (OUT) jack only when the “HDMI1” or “HDMI2” function is selected.
- To send an audio signal from the HDMI (IN 1/2) jacks to the HDMI (OUT) jack, you may need to change the audio output setting. For details, see [Audio Output] in [Audio Settings] (page 44).

## When you make connection **B, C**

Connect the system so that video signals from the system and other component are sent to the TV, and audio signals from the component are sent to the system.

### Note

- If you make connection **B, C**, set [Control for HDMI] in [HDMI Settings] of [System Settings] to [Off] (page 46).
- You can enjoy component sound by selecting the “AUDIO” function for connection **B**.

## Connecting the antenna (aerial)

Rear panel of the unit

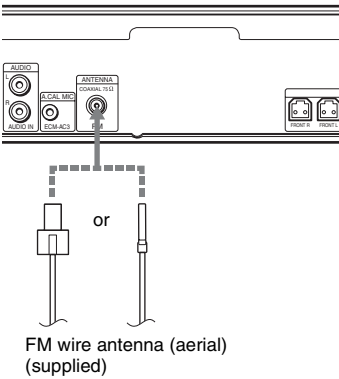

### Note

- Be sure to fully extend the FM wire antenna (aerial).
- After connecting the FM wire antenna (aerial), keep it as horizontal as possible.

### Tip

- If you have poor FM reception, use a 75-ohm coaxial cable (not supplied) to connect the unit to an outdoor FM antenna (aerial).

## Step 3: Preparing for Network Connection

### Tip

- To connect the system to your network, perform [Easy Network Settings]. For details, see “Step 5: Performing the Easy Setup” (page 22).

Select the method based on your LAN (Local Area Network) environment.

- If you use a wireless LAN  
The system has built-in Wi-Fi, and you can connect the system to the network by making the network settings.
- If you use other than a wireless LAN  
Connect to the network by making a LAN cable connection as follows.

Rear panel of the unit

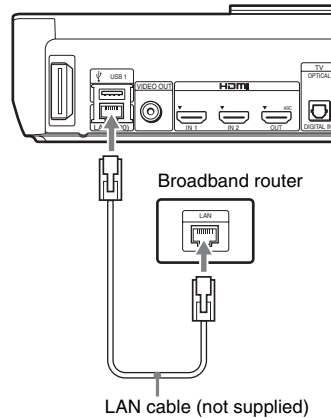

### Before performing the network settings

When your wireless LAN router (access point) is Wi-Fi Protected Setup (WPS)-compatible, you can easily set the network settings with the WPS button.

If not, check the following information in advance, and record it in the space provided below.

- The network name (SSID\*) that identifies your network\*\*.

- If security is set on your wireless network, the security key (WEP key, WPA key)\*\*.

\* SSID (Service Set Identifier) is a name that identifies a particular wireless network.

\*\* You need to check the settings of your wireless LAN router to get the information about SSID and security key. For details:

- visit the following website:  
<http://www.sony.com/blurayhtsupport/>
- refer to the instruction manual supplied with the wireless LAN router
- consult the manufacturer of the wireless LAN router

### About wireless LAN security

Since communication via the wireless LAN function is established by radio waves, the wireless signal may be susceptible to interception. To protect wireless communication, this system supports various security functions. Be sure to correctly configure the security settings in accordance with your network environment.

#### ■ No Security

Although you can easily make settings, anyone can intercept wireless communication or intrude into your wireless network, even without any sophisticated tools. Keep in mind that there is a risk of unauthorized access or interception of data.

#### ■ WEP

WEP applies security to communications to prevent outsiders from intercepting communications or intruding into your wireless network. WEP is a legacy security technology that enables older devices which do not support TKIP/AES to be connected.

#### ■ WPA-PSK (TKIP), WPA2-PSK (TKIP)

TKIP is a security technology developed in response to the deficiencies of WEP. TKIP assures a higher security level than WEP.

#### ■ WPA-PSK (AES), WPA2-PSK (AES)

AES is a security technology that uses an advanced security method distinct from WEP and TKIP.

AES assures a higher security level than WEP or TKIP.

## Step 4: Setting up the Wireless System

The unit transmits sound to the surround amplifier that is connected to the surround speakers. To activate wireless transmission, perform the following Steps.

### 1 Insert the wireless transceiver into the unit.

Rear panel of the unit

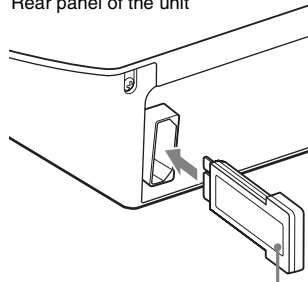

Wireless transceiver

### 2 Insert the wireless transceiver into the surround amplifier.

Rear panel of the surround amplifier

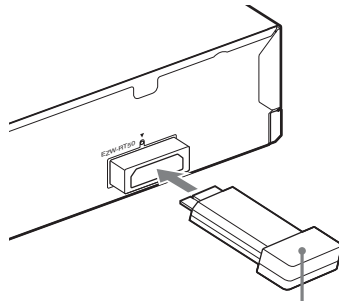

Wireless transceiver

### 3 Connect the AC power cord (mains lead) of the unit.

Before connecting the AC power cord, make sure all connections in “Step 2: Connecting the System” (page 14) are secure.

- 4** Press **I/⏻** to turn the system on.



- 5** Connect the AC power cord (mains lead) of the surround amplifier.

LINK/STANDBY indicator

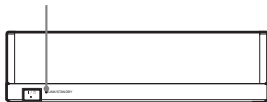

When wireless transmission is activated, the LINK/STANDBY indicator turns green.

If the LINK/STANDBY indicator does not turn on, see “Wireless sound” (page 53).

## About the LINK/STANDBY indicator

The LINK/STANDBY indicator shows wireless transmission status, as follows.

Indicator	Status
Turns green.	The system is turned on, wireless transmission is activated and surround signals are being received.
Turns orange.	The system is turned on, wireless transmission is activated with the Secure Link function, and surround signals are being received.
Flashes green or orange slowly.	Wireless transmission is deactivated.
Turns red.	The surround amplifier is in standby mode while the system is in standby mode or wireless transmission is deactivated.
Turns off.	The surround amplifier is turned off.
Flashes green quickly.	The wireless transceiver is not inserted correctly into the wireless transceiver slot.
Flashes red.	The surround amplifier's protection is active.

## About the standby mode

The surround amplifier enters standby mode automatically when the main unit is in standby mode or wireless transmission is deactivated. The surround amplifier turns on automatically when the main unit is turned on and wireless transmission is activated.

## To specify the wireless connection

If you use multiple wireless products or your neighbors use wireless products, interference may occur. To prevent this, you can specify the wireless connection to link the main unit to the surround amplifier (Secure Link function). For details, see “Further Settings for the Wireless System” (page 40).

## Step 5: Performing the Easy Setup

Follow the Steps below to make the basic adjustments and network settings for the system. Displayed items vary depending on the country model.

- 1 Insert two R6 (size AA) batteries (supplied) by matching the ⊕ and ⊖ ends on the batteries to the markings inside the compartment.**

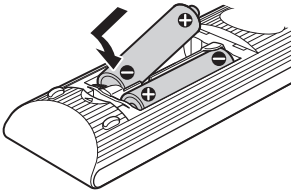

- 2 Turn on the TV.**
- 3 Press I/⏻.**
- 4 Switch the input selector on your TV so that the signal from the system appears on the TV screen.**

The Easy Setup Display for OSD language selection appears.

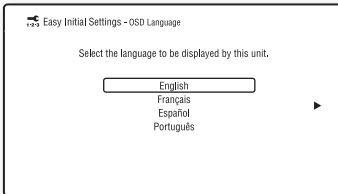

- 5 Perform [Easy Initial Settings]. Follow the on-screen instructions to make the basic settings using ←/↑/↓/→ and ⊕.**

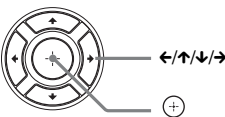

- Depending on the connection method (page 16), perform the following setting.
- HDMI cable connection: Follow the instructions that are displayed on the TV screen.
  - Video cord connection: Select [16:9] or [4:3] so that the picture is displayed correctly.

For details about [Auto Calibration] settings in [Easy Initial Settings], see “Calibrating the Appropriate Speaker Settings Automatically” (page 35).

- 6 After completing of [Easy Initial Settings], perform [Easy Network Settings]. Press ←/↑/↓/→ to select [Easy Network Settings], then press ⊕.**

The Easy Network Settings display appears.

- 7 Follow the on-screen instructions to make the network settings using ←/↑/↓/→ and ⊕.**

If the system cannot connect to the network, see “Network connection” (page 55) or “Wireless LAN connection” (page 55).

### To recall the Easy Initial Settings display/Easy Network Settings display

- 1 Press HOME.**  
The home menu appears on the TV screen.
- 2 Press ←/→ to select  [Setup].**
- 3 Press ↑/↓ to select [Easy Setup], then press ⊕.**
- 4 Press ↑/↓ to select the setting, then press ⊕.**
  - [Easy Initial Settings]
  - [Easy Network Settings]

The Easy Initial Settings display/Easy Network Settings display appears.



## Step 6: Selecting the Source

You can select the playback source.



**Press FUNCTION repeatedly until the desired function appears in the front panel display.**

When you press FUNCTION once, the current function appears in the front panel display, then each time you press FUNCTION, the function changes as follows.

“BD/DVD” → “USB1” → “USB2” → “FM”  
→ “HDMI1” → “HDMI2” → “TV” →  
“AUDIO” → “BD/DVD” → ...

Function	Source
“BD/DVD”	Disc or network device to be played by the system
“USB1”/“USB2”	USB device or iPod/iPhone that is connected to the  USB 1 (page 10) or  USB 2 port (page 9)
“FM”	FM radio (page 34)
“HDMI1”/ “HDMI2”	Component that is connected to the HDMI (IN 1) or HDMI (IN 2) jack on the rear panel (page 17)
“TV”	Component (TV, etc.) that is connected to the TV (DIGITAL IN OPTICAL) jack on the rear panel, or a TV compatible with the Audio Return Channel function that is connected to the HDMI (OUT) jack on the rear panel (page 16)
“AUDIO”	Component that is connected to the AUDIO (AUDIO IN L/R) jacks on the rear panel (page 17)

### Tip

Some functions may be changed via the TV screen by pressing FUNCTION, , , and .

## Step 7: Enjoying Surround Sound

After performing the previous Steps and starting playback, you can easily enjoy pre-programmed sound modes that are tailored to different kinds of sound sources. They bring the exciting and powerful sound of movie theaters into your home.

### Selecting the sound mode

**Press SOUND MODE +/- repeatedly during playback until the desired mode appears in the front panel display or on the TV screen.**

You can select the following items. The text enclosed in brackets ([--]) appears on the TV screen, and the text enclosed in double quotation mark (“--”) appears in the front panel display.

Sound mode	Effect
[Auto] (“AUTO”)	The system selects [Movie] or [Music] automatically to produce the sound effect depending on the disc or sound stream. <ul style="list-style-type: none"> <li>• 2-channel source: The system simulates surround sound from 2-channel sources and outputs sound from the 5.1 channel speakers by duplicating 2-channel source sound across each speaker.</li> <li>• Multi-channel source: The system outputs sound from the speakers depending on the number of channels of the source.</li> </ul>
[Movie] (“MOVIE”)	The system provides the optimized sound for watching movies.
[Music] (“MUSIC”)	The system provides the optimized sound for listening to music.
[Audio Enhancer] (“ENHANCER”)	The system optimizes 2-channel sources by enhancing sound lost by audio compression. Sound volume is automatically adjusted so that you can enjoy audio contents with inconsistent volume.

Sound mode	Effect
[3D Surround] ("3D SUR.")	[3D Surround] is a unique Sony algorithm that provides a 3D sound experience with depth and presence by creating a virtual sound field close to your ears.
[Sports] ("SPORTS")	The system provides optimized sound for watching sports programs.
[Night] ("NIGHT")	Suitable for watching movies at night by reducing loud sounds while maintaining clear dialog.
[Hall] ("HALL")	The system creates sound as though you were listening in a concert hall.
[2ch Stereo] ("2CH ST.")	The system outputs the sound from the front speakers and subwoofer regardless of sound format or number of channels.
[Demo Sound] ("DEMO SND")	The system provides ear-catching sound, suitable for presentations, etc.

**Tip**

- If you set the sound mode to [Auto] and play Internet content of the Berlin Philharmonic, the system enters to "BERLIN PHILHARMONIC HALL" mode automatically (only for areas that are offered the service).

## To select the sound mode from the option menu

- 1** Press **OPTIONS** and **↑/↓** to select [Sound Mode], then press **⊕**.
- 2** Press **↑/↓** to select the sound mode, then press **⊕**.

**Note**

- The sound mode can be selected only when [Sound Effect] is set to [Sound Mode On] (page 44). When [Sound Effect] is set to other than [Sound Mode On], the sound mode setting does not apply.

**Tip**

- To enjoy 2-channel source in such as a CD multi-channel output, select [Auto], [Sports], [3D Surround], or [Hall].



## Playing a Disc

For playable discs, see “Playable Discs” (page 55).

**1 Switch the input selector on your TV so that the signal from the system appears on your TV screen.**

**2 Load a disc.**

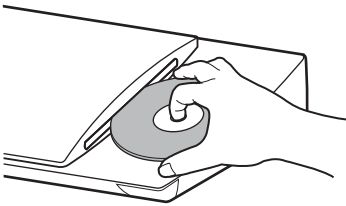

Playback starts.

If playback does not start automatically, select in the [Video], [Music], or [Photo] category, and press .

## Enjoying BONUSVIEW/BD-LIVE

Some BD-ROMs with “BD-LIVE Logo\*” have bonus content and other data that can be downloaded for enjoyment.

\* BD-LIVE™

**1 Connect the USB device to the USB 1 port (page 10).**

For local storage, use a 1 GB or larger USB memory.

**2 Prepare for BD-LIVE (BD-LIVE only).**

- Connect the system to a network (page 19).
- Set [BD Internet Connection] to [Allow] (page 45).

**3 Insert a BD-ROM with BONUSVIEW/BD-LIVE.**

The operation method differs depending on the disc. Refer to the operating instructions of the disc.

**Tip**

- To delete data in the USB memory, select [Erase BD Data] in [Video], and press . All data stored in the buda folder will be deleted.

## Enjoying Blu-ray 3D

You can enjoy Blu-ray 3D Discs with the 3D logo\*.



**1 Prepare for Blu-ray 3D Disc playback.**

- Connect the system to your 3D-compatible TV using a High Speed HDMI cable (supplied with BDV-T79 only).
- Set [3D Output Setting] and [TV Screen Size Setting for 3D] in [Screen Settings] (page 43).

**2 Insert a Blu-ray 3D Disc.**

The operation method differs depending on the disc. Refer to the operating instructions supplied with the disc.

**Tip**

- Refer also to the operating instructions of your 3D-compatible TV.

## Displaying the playback information

You can check the playback information, etc., by pressing DISPLAY.  
The displayed information differs depending on the disc type and system status.

Example: when playing a BD-ROM

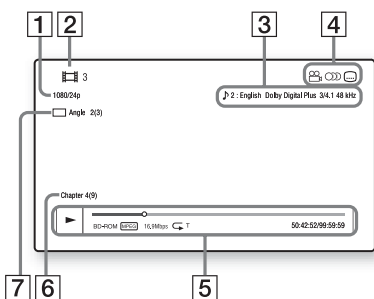

- 1 Output resolution/Video frequency
- 2 Title number or name
- 3 The currently selected audio setting
- 4 Available functions (angle, audio, subtitle)
- 5 Playback information  
Displays play mode, playing status bar, disc type, video codec, bit rate, repeat type, elapsed time, total playing time
- 6 Chapter number
- 7 The currently selected angle

## Playing from a USB Device

You can play video/music/photo files on a connected USB device.

For playable types of files, see “Playable Types of Files” (page 56).

- 1 **Connect the USB device to the USB 1 port (page 10) or USB 2 port (page 9).**

Refer to the operating instructions of the USB device before connecting.

- 2 **Press HOME.**  
The home menu appears on the TV screen.
- 3 **Press ←/→ to select [Video], [Music], or [Photo].**
- 4 **Press ↑/↓ to select [USB device (USB1)] or [USB device (USB2)], then press +.**

### Note

- Do not remove the USB device during operation. To avoid data corruption or damage to the USB device, turn the system off before connecting or removing the USB device.

# Enjoying an iPod/iPhone



You can enjoy the music/video/photo and charge the battery of an iPod/iPhone via the system.

## Compatible iPod/iPhone models

Update your iPod/iPhone with the latest software before using with the system.

Made for iPod touch 4th generation, iPod touch 3rd generation, iPod touch 2nd generation, iPod nano 6th generation, iPod nano 5th generation (video camera), iPod nano 4th generation (video), iPod nano 3rd generation (video), iPod classic, iPhone 4S, iPhone 4, iPhone 3GS, iPhone 3G

## To enjoy an iPod/iPhone via the system



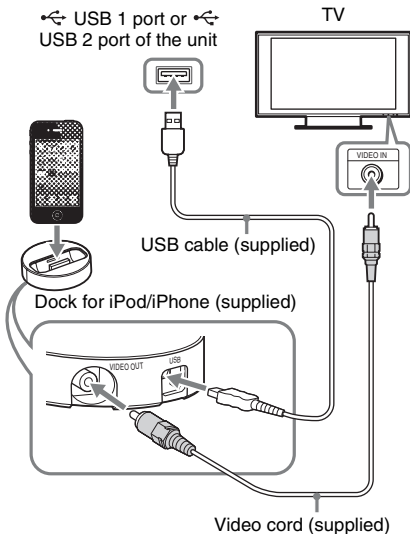

- 1** Connect the Dock for iPod/iPhone to the  USB 1 port (page 10) or  USB 2 port (page 9), then place the iPod/iPhone onto the Dock for iPod/iPhone.





When you play a video/photo file, connect the video out jack of the Dock for iPod/iPhone to the video input jack of your TV with a video cord before placing the iPod/iPhone onto the Dock for iPod/iPhone.



- 2** Press HOME.

The home menu appears on the TV screen.

- 3** Press  to select  [Video],  [Music], or  [Photo].





- 4** Press  to select  [iPod (USB1)] or  [iPod (USB2)], then press .

■ If you selected [Video] or [Music] in Step 3

The video/music files are listed on the TV screen. Go to the next Step.

■ If you selected [Photo] in Step 3

[Please change the TV input to the video input...] appears on the TV screen. Switch the input selector on your TV so that the signal from the iPod/iPhone appears on your TV screen. Then, start the slideshow by operating the iPod/iPhone directly.

- 5** Press , , , and  to select the file that you want to play.

The sound from the iPod/iPhone is played on the system.

When you play a video file, switch the input selector on your TV so that the signal from the iPod/iPhone appears on your TV screen. You can operate the iPod/iPhone using the buttons on the supplied remote.

For operation details of the iPod/iPhone, also refer to the operating instructions of the iPod/iPhone.

### Note

- To change a system setting, such as the sound mode setting, while viewing images from your iPod/iPhone on your TV, select the input on your TV for this system before operating the system.
- The iPod/iPhone is charged when connected to the system while the system is turned on.
- Sony cannot accept responsibility in the event that data recorded to iPod/iPhone is lost or damaged when using an iPod/iPhone connected to this unit.
- Do not remove the iPod/iPhone during operation. To avoid data corruption or damage to the iPod/iPhone, turn the system off when connecting or removing the iPod/iPhone.
- The system only recognizes an iPod/iPhone that has previously been connected to the system.
- The System Audio Control function does not work while playing video/photo files via the iPod/iPhone.
- The system can recognize up to 5,000 files (including folders).

# Playing via a Network

## Enjoying Sony Entertainment Network (SEN)

Sony Entertainment Network serves as a gateway delivering selected Internet content and a variety of on-demand entertainment straight to your unit.

### Tip

- Some Internet content requires registration via a PC before it can be played. For further details, visit the following website:  
<http://www.sony.com/blurrayhtsupport/>
- Some Internet content may not be available in some regions/countries.

### 1 Prepare for Sony Entertainment Network.

Connect the system to a network (page 19).

### 2 Press SEN.

### 3 Press **</>** to select the Internet content and a variety of on-demand entertainment, then press **+**.

## Video streaming control panel

The control panel appears when a video file starts playing. The displayed items may differ depending on the Internet content provider. To display again, press DISPLAY.

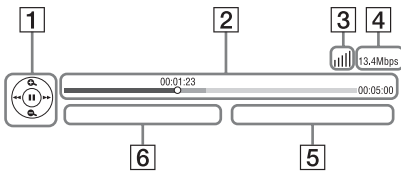

- 1 Control display  
Press **</>** or **+** for playback operations.
- 2 Playing status bar  
Status bar, cursor indicating the current position, playing time, duration of the video file

- 3 Network condition indicator  
 Indicates signal strength for a wireless connection.  
 Indicates a wired connection.
- 4 Network transmission speed
- 5 The next video file name
- 6 The currently selected video file name

## Playing files on a Home Network (DLNA)

You can play video/music/photo files on other DLNA-certified components by connecting them to your home network.

This unit can be used as a player and renderer.

- Server: Stores and sends files
- Player: Receives and plays files from the server
- Renderer: Receives and plays files from the server, and can be operated by another component (controller)
- Controller: Operates the renderer component

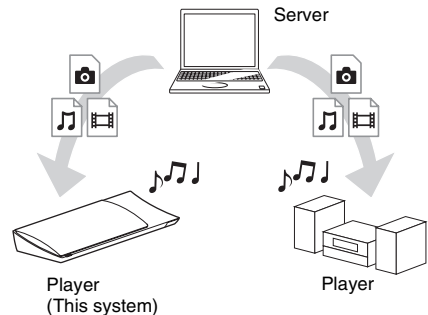

### Prepare for using the DLNA function.

- Connect the system to a network (page 19).
- Prepare other DLNA-certified components. For details, see the operating instructions of the components.

## To play files stored on a DLNA server via the system (DLNA Player)

Select the DLNA server icon from [Video], [Music], or [Photo] in the home menu, then select the file that you want to play.

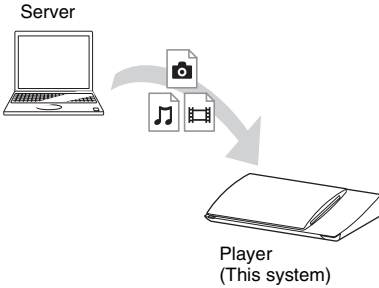

## To play remote files by operating the system (Renderer) via a DLNA controller

You can operate the system with a DLNA-certified controller, such as iPhone, when playing files stored on a DLNA server.

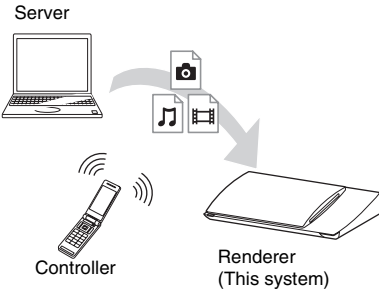

Control this system using a DLNA controller. For details of operation, see the operating instructions of the DLNA controller.

**Note**

- Do not operate the system with the supplied remote and a DLNA controller at the same time.
- For details about the DLNA controller, refer to the operating instructions of the DLNA controller.

**Tip**

- The system is compatible with the “Play To” function of Windows Media® Player 12 that comes standard with Windows 7.

## Playing the same music in different rooms (PARTY STREAMING)

You can play the same music at the same time across all Sony components which are compatible with the PARTY STREAMING function and connected to your home network. Contents in [Music] and the “FM” and “AUDIO” functions can be used with the PARTY STREAMING function.

There are two kinds of PARTY STREAMING-compatible components.

- PARTY host: Plays and sends music.
- PARTY guest: Plays music that is sent from PARTY host.

This unit can be used as a PARTY host or PARTY guest.

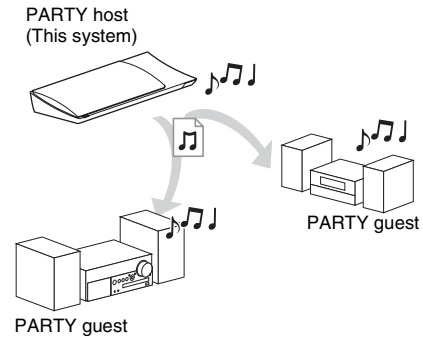

### Prepare for PARTY STREAMING.

- Connect the system to a network (page 19).
- Connect components which are compatible with the PARTY STREAMING function.

### To use the system as the PARTY host

Select a track in [Music], a radio station in [Radio], or [AUDIO] in [Input], press **OPTIONS**, then select [Start PARTY] from the options menu to start.

To close, press **OPTIONS**, then select [Close PARTY] from the options menu.

**Note**

- If content that is not compatible with the PARTY STREAMING function is played, the system closes PARTY automatically.

## To use the system as a PARTY guest

Select [PARTY] in [Music], then select the PARTY host device icon.

To leave the PARTY, press OPTIONS, then select [Leave PARTY].

To close the PARTY, press OPTIONS, then select [Close PARTY].

**Note**

- The sale and product lineup of products that are compatible with the PARTY STREAMING function differ depending on the area.

## Searching for video/music information

You can acquire content information using Gracenote technology and search for related information.

- 1 Connect the system to a network (page 19).**
- 2 Insert a disc with content about which you want to search.**  
You can perform a video search from a BD-ROM or DVD-ROM, and a music search from a CD-DA (music CD).
- 3 Press to select [Video] or [Music].**
- 4 Press to select [Video Search] or [Music Search].**  
The content information is displayed.

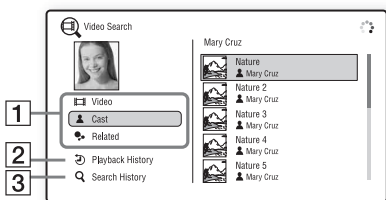

- 1 Content details**  
Displays a list of related information, such as title, cast, track, or artist.
- 2 [Playback History]**  
Displays a list of previously played BD-ROM/DVD-ROM/CD-DA (music CD) titles. Select a title to acquire content information.
- 3 [Search History]**  
Displays a list of previous searches performed via the [Video Search] or [Music Search] function.

## To search for further related information

Select an item in the lists, then select the service for searches.

## Available Options

Various settings and playback operations are available by pressing OPTIONS. The available items differ depending on the situation.

### Common options

Item	Details
[Sound Mode]	Changes the sound mode setting (page 23).
[Shuffle Setting] (iPod/iPhone only)	Sets shuffle playback.
[Repeat Setting]	Sets repeat playback.
[3D Menu]	[Simulated 3D]: Adjusts the simulated 3D effect. [3D Depth Adjustment]: Adjusts the depth of 3D images. [2D Playback]: Sets playback to 2D image.
[Play/Stop]	Starts or stops playback.
[Play from beginning]	Plays the item from the beginning.
[Start PARTY]	Starts a party with the selected source. This item may not appear depending on the source.

Item	Details
[Leave PARTY]	Leaves from a party which the system is participating in. The PARTY STREAMING function continues among other participating devices.
[Close PARTY]	For PARTY host: Closes a party. For PARTY guest: Closes a party which the system is participating in. The PARTY STREAMING function ends for all other participating devices.

### [Video] only

Item	Details
[A/V SYNC]	Adjusts the gap between picture and sound. For details, see “Adjusting the delay between the picture and sound” (page 32).
[3D Output Setting]	Sets whether or not to output 3D video automatically.  <b>Note</b> • 3D video from the HDMI (IN 1) or HDMI (IN 2) jack is output regardless of this setting.

Item	Details
[Video Settings]	<ul style="list-style-type: none"> <li>• [Picture Quality Mode]: Selects the picture settings. [Auto], [Custom1], and [Custom2] are available only for HDMI connections.</li> <li>• [Texture Remaster]: Adjusts the sharpness and detail of the edges.</li> <li>• [Super Resolution]: Improves the resolution.</li> <li>• [Smoothing]: Reduces on-screen banding by smoothing gradations on flat areas.</li> <li>• [Contrast Remaster]: Automatically arranges the black and white levels so that the screen is not too dark and the image is modulated.</li> <li>• [Clear Black]: Adjusts the display of the dark elements of the image. All shading is not suppressed; it allows beautifully reproduced black tones.</li> </ul>
[Pause]	Pauses playback.
[Top Menu]	Displays the BD's or DVD's Top Menu.
[Menu/Popup Menu]	Displays the BD-ROM's Pop-up Menu or DVD's menu.
[Title Search]	Searches for a title on BD-ROMs/DVD VIDEOS and starts playback from the beginning.
[Chapter Search]	Searches for a chapter and starts playback from the beginning.
[Audio]	Selects the audio format/track.
[Subtitle]	Selects the subtitle language when multilingual subtitles are recorded on a BD-ROM/DVD VIDEO.
[Angle]	Switches to other viewing angles when multi-angles are recorded on BD-ROMs/DVD VIDEOS.
[IP Content NR Pro]	Adjusts the picture quality of Internet content.

Item	Details
[Video Search]	Displays information on the BD-ROM/DVD-ROM based on Gracenote technology.

## 🎵 [Music] only

Item	Details
[Add Slideshow BGM]	Registers music files in the USB memory as slideshow background music (BGM).
[Music Search]	Displays information on the audio CD (CD-DA) based on Gracenote technology.

## 📷 [Photo] only

Item	Details
[Slideshow]	Starts a slideshow.
[Slideshow Speed]	Changes the slideshow speed.
[Slideshow Effect]	Sets the effect when playing a slideshow.
[Slideshow BGM]	<ul style="list-style-type: none"> <li>• [Off]: Turns off the function.</li> <li>• [My Music from USB]: Sets the music files registered in [Add Slideshow BGM].</li> <li>• [Play from Music CD]: Sets the tracks on CD-DAs (music CDs).</li> </ul>
[Change Display]	Switches between [Grid View] and [List View].
[Rotate Left]	Rotates the photo counterclockwise by 90 degrees.
[Rotate Right]	Rotates the photo clockwise by 90 degrees.
[View Image]	Displays the selected picture.

## Adjusting the delay between the picture and sound

### (A/V SYNC)

When the sound does not match the pictures on the TV screen, you can adjust the delay between the picture and sound.

The setting method differs depending on the function.

### When playing via other than the “FM” or “TV” function

- 1 Press OPTIONS.**  
The option menu appears on the TV screen.
- 2 Press  $\uparrow/\downarrow$  to select [A/V SYNC], then press  $\oplus$ .**
- 3 Press  $\leftarrow/\rightarrow$  to adjust the delay between the picture and sound.**  
You can adjust from 0 ms to 300 ms in 25 ms increments.
- 4 Press  $\oplus$ .**  
The setting is made.

### When playing via the “TV” function

- 1 Press OPTIONS.**  
The option menu appears in the front panel display.
- 2 Press  $\uparrow/\downarrow$  repeatedly until “A/V SYNC” appears in the front panel display, then press  $\oplus$  or  $\rightarrow$ .**
- 3 Press  $\uparrow/\downarrow$  to adjust the delay between the picture and sound.**  
You can adjust from 0 ms to 300 ms in 25 ms increments.
- 4 Press  $\oplus$ .**  
The setting is made.
- 5 Press OPTIONS.**  
The option menu in the front panel display turns off.



## Selecting the Audio Format, Multilingual Tracks, or Channel

When the system is playing a BD/DVD VIDEO recorded in multiple audio formats (PCM, Dolby Digital, MPEG audio, or DTS) or multilingual tracks, you can change the audio format or language.

With a CD, you can select the sound from the right or left channel and listen to the sound of the selected channel through both the right and left speakers.

**Press AUDIO repeatedly during playback to select the desired audio signal.**

The audio information appears on the TV screen.

### ■ BD/DVD VIDEO

Depending on the BD/DVD VIDEO, the choice of language varies.

When 4 digits are displayed, they indicate a language code. See “Language Code List” (page 60) to confirm which language the code represents. When the same language is displayed two or more times, the BD/DVD VIDEO is recorded in multiple audio formats.

### ■ DVD-VR

The types of sound tracks recorded on a disc are displayed.

Example:

- [♪ Stereo]
- [♪ Stereo (Audio1)]
- [♪ Stereo (Audio2)]
- [♪ Main]
- [♪ Sub]
- [♪ Main/Sub]

#### Note

- [♪ Stereo (Audio1)] and [♪ Stereo (Audio2)] do not appear when only one audio stream is recorded on the disc.

### ■ CD

- [♪ Stereo]: The standard stereo sound.
- [♪ 1/L]: The sound of the left channel (monaural).
- [♪ 2/R]: The sound of the right channel (monaural).
- [♪ L+R]: The sound of both the left and right channels output from each individual speaker.

## Enjoying Multiplex Broadcast Sound

### (DUAL MONO)

You can enjoy multiplex broadcast sound when the system receives or plays a Dolby Digital multiplex broadcast signal.

#### Note

- To receive a Dolby Digital signal, you need to connect a TV or other component to the TV (DIGITAL IN OPTICAL) jack with a digital optical cord (pages 16, 17). If your TV’s HDMI IN jack is compatible with the Audio Return Channel function (pages 16,46), you can receive a Dolby Digital signal via an HDMI cable.

**Press AUDIO repeatedly until the desired signal appears in the front panel display.**

- “MAIN”: Sound of the main language will be output.
- “SUB”: Sound of the sub language will be output.
- “MAIN/SUB”: Mixed sound of both the main and sub languages will be output.

## Listening to the Radio

**1** Press **FUNCTION** repeatedly until “FM” appears in the front panel display.

**2** Select the radio station.

### Automatic tuning

Press and hold **TUNING +/-** until the auto scanning starts.

[Auto Tuning] appears on the TV screen.

Scanning stops when the system tunes in a station.

To cancel automatic tuning, press any buttons other than **VOL +/-**.

### Manual tuning

Press **TUNING +/-** repeatedly.

**3** Adjust the volume by pressing **VOL +/-**.

### If an FM program is noisy

If an FM program is noisy, you can select monaural reception. There will be no stereo effect, but reception will improve.

**1** Press **OPTIONS**.

The option menu appears on the TV screen.

**2** Press **↑/↓** to select [FM Mode], then press **⊕**.

**3** Press **↑/↓** to select [Monaural].

- [Stereo]: Stereo reception.
- [Monaural]: Monaural reception.

**4** Press **⊕**.

The setting is made.

#### Tip

- You can set [FM Mode] to each preset station separately.

### To turn off the radio

Press **I/O**.

## Presetting radio stations

You can preset up to 20 stations. Before tuning, make sure to turn down the volume to minimum.

**1** Press **FUNCTION** repeatedly until “FM” appears in the front panel display.

**2** Press and hold **TUNING +/-** until the auto scanning starts.

Scanning stops when the system tunes in a station.

**3** Press **OPTIONS**.

The option menu appears on the TV screen.

**4** Press **↑/↓** to select [Preset Memory], then press **⊕**.

**5** Press **↑/↓** to select the preset number you want, then press **⊕**.

**6** Repeat Steps 2 to 5 to store other stations.

### To change a preset number

Select the desired preset number by pressing **PRESET +/-**, then perform the procedure from Step 3.

## Selecting a preset station

**1** Press **FUNCTION** repeatedly until “FM” appears in the front panel display.

The last received station is tuned in.

**2** Press **PRESET +/-** repeatedly to select the preset station.

The preset number and frequency appear on the TV screen and front panel display.

Each time you press the button, the system tunes in one preset station.

#### Tip

- You can select the preset station number directly by pressing the number buttons.
- Each time you press **DISPLAY**, the display in the front panel display changes as follows:  
Frequency → Preset number → Decoding status\* → Frequency → ...

\*Appears when [Sound Effect] is set to [Dolby Pro Logic], [DTS Neo:6 Cinema], or [DTS Neo:6 Music] (page 44).

# Using the Control for HDMI Function for “BRAVIA” Sync

This function is available on TVs with the “BRAVIA” Sync function.

By connecting Sony components that are compatible with the Control for HDMI function via an HDMI cable, operation is simplified.

### Note

- To use the “BRAVIA” Sync function, turn on the system and all components that are connected to the system after connecting them with an HDMI cable.

## Control for HDMI - Easy Setting

You can set the system’s [Control for HDMI] function automatically by enabling the corresponding setting on the TV.

For details about the Control for HDMI function, see “[HDMI Settings]” (page 46)

## System Power Off

You can turn the system off in sync with the TV.

### Note

- The system does not turn off automatically while playing music or when set to the “FM” function.

## One-Touch Play

When you press **▶** on the remote, the system and your TV turn on, and your TV’s input is set to the HDMI input to which the system is connected.

## System Audio Control

You can simplify operation to enjoy sound from the TV or other components.

You can use the System Audio Control function as follows:

- When the system is turned on, the sound of the TV or other components can be output from the speakers of the system.
- When sound from the TV or other components is output via the speakers of the system, you

can change the speakers to which TV sound is output by pressing **SPEAKERS TV**  $\leftrightarrow$  **AUDIO**.

- When sound from the TV or other components is output via the speakers of the system, you can adjust the volume and turn off the sound of the system by operating the TV.

## Audio Return Channel

You can enjoy TV sound via the system by using just one HDMI cable. For details of the setting, see “[Audio Return Channel]” (page 46).

## Language Follow

When you change the language for the on-screen display of the TV, the system’s on-screen display language is also changed after turning the system off and on.

## Routing Control

When you perform One-Touch Play on the connected component, the system turns on and sets the system’s function to “HDMI1” or “HDMI2” (depending on the HDMI input jack in use), and your TV’s input is automatically set to the HDMI input to which the system is connected.

# Calibrating the Appropriate Speaker Settings Automatically

## [Auto Calibration]

D.C.A.C. (Digital Cinema Auto Calibration) brings you the ideal sound experience by automatically adjusting the setting of the speakers’ distance, location, and characteristic.

### Note

- The system outputs a loud test sound when [Auto Calibration] starts. You cannot turn the volume down. Give consideration to children and neighbors.
- Before [Auto Calibration], make sure that all the speakers are connected to the unit and surround amplifier.

## 1 Press HOME.

The home menu appears on the TV screen.

- 2** Press **←/→** to select ** [Setup]**.
- 3** Press **↑/↓** to select **[Audio Settings]**, then press **⊕**.
- 4** Press **↑/↓** to select **[Auto Calibration]**, then press **⊕**.

The confirmation display for [Auto Calibration] appears.

- 5** **Connect the calibration mic to the A.CAL MIC jack on the rear panel.**

Set up the calibration mic at ear level using a tripod, etc. (not supplied). The front of each speaker should face the calibration mic, and there should be no obstruction between the speakers and the calibration mic.

- 6** Press **↑/↓** to select **[OK]**.

To cancel, select [Cancel].

- 7** Press **⊕**.

[Auto Calibration] starts.

The system adjusts the speaker settings automatically.

Be quiet during the measurement.

**Note**

- Before [Auto Calibration], make sure that the surround amplifier is turned on and you install the surround amplifier in an appropriate location to ensure wireless connection with it.

- 8** **Confirm the result of [Auto Calibration].**

The distance and level for each speaker appear on the TV screen.

**Note**

- If measurement fails, follow the message then retry [Auto Calibration].

- 9** Press **↑/↓** to select **[OK]** or **[Cancel]**, then press **⊕**.

■ **The measurement is OK.**

Disconnect the calibration mic, then select [OK]. The result is implemented.

■ **The measurement is not OK.**

Follow the message, then select [OK] to retry.

**Note**

- While [Auto Calibration] is in progress, do not operate the system.

**Tip**

- You can change the unit of measurement (feet or meters) by pressing the color button (RED).

---

## Setting the Speakers

### [Speaker Settings]

To obtain the best possible surround sound, set the speakers' distance from your listening position. Then use the test tone to adjust the balance of the speakers.

- 1** Press **HOME**.

The home menu appears on the TV screen.

- 2** Press **←/→** to select ** [Setup]**.

- 3** Press **↑/↓** to select **[Audio Settings]**, then press **⊕**.

- 4** Press **↑/↓** to select **[Speaker Settings]**, then press **⊕**.

The [Speaker Settings] display appears.

- 5** Press **↑/↓** to select the item, then press **⊕**.

Check the following settings.

---

### ■ [Distance]

When you move the speakers, be sure to set the parameters of the distance from the listening position to the speakers.

You can set the parameters from 0 to 23 feet (0.0 to 7.0 meters).

[Front Left/Right] 10 ft/3.0 m: Set the front speaker distance.

[Center] 10 ft/3.0 m: Set the center speaker distance.

[Surround Left/Right] 10 ft/3.0 m: Set the surround speaker distance.

[Subwoofer] 10 ft/3.0 m: Set the subwoofer distance.

**Tip**

- You can change the unit of measurement (feet or meters) by pressing the color button (RED).

---

### ■ [Level]

You can adjust the sound level of the speakers. You can set the parameters from -6.0 dB to +6.0

dB. Be sure to set [Test Tone] to [On] for easy adjustment.

[Front Left/Right] 0.0 dB: Set the front speaker level.

[Center] 0.0 dB: Set the center speaker level.

[Surround Left/Right] 0.0 dB: Set the surround speaker level.

[Subwoofer] 0.0 dB: Set the subwoofer level.

### ■ [Relocation]

You can correct the speaker position virtually to improve the surround effect.

[On]: You can hear sound from a virtually relocated speaker position determined by [Auto Calibration].

[Off]: You can hear sound from the actual speaker position.

#### Note

- This setting is reflected after performing [Auto Calibration].

### ■ [Test Tone]

The speakers will emit a test tone to adjust [Level].

[Off]: The test tone is not emitted from the speakers.

[On]: The test tone is emitted from each speaker in sequence while adjusting level. When you select one of the [Speaker Settings] items, the test tone is emitted from each speaker in sequence.

Adjust the sound level as follows.

- 1 Set [Test Tone] to [On].
- 2 Press  $\uparrow/\downarrow$  to select [Level], then press  $\oplus$ .
- 3 Press  $\uparrow/\downarrow$  to select the desired speaker type, then press  $\oplus$ .
- 4 Press  $\leftarrow/\rightarrow$  to select the left or right speaker, then press  $\uparrow/\downarrow$  to adjust the level.
- 5 Press  $\oplus$ .
- 6 Repeat Steps 3 to 5.
- 7 Press RETURN.

The system returns to the previous display.

- 8 Press  $\uparrow/\downarrow$  to select [Test Tone], then press  $\oplus$ .

- 9 Press  $\uparrow/\downarrow$  to select [Off], then press  $\oplus$ .

#### Note

- The test tone signals are not output from the HDMI (OUT) jack.

#### Tip

- To adjust the volume of all the speakers at one time, press VOL +/-.

## Using the Sleep Timer

You can set the system to turn off at a preset time, so you can fall asleep listening to music. The time can be preset in intervals of 10 minutes.

### Press SLEEP.

Each time you press SLEEP, the minutes display (the remaining time) in the front panel display changes by 10 minutes.

When you set the sleep timer, the remaining time appears every 5 minutes.

When the remaining time is less than 2 minutes, "SLEEP" flashes in the front panel display.

### To check the remaining time

Press SLEEP once.

### To change the remaining time

Press SLEEP repeatedly to select the desired time.

---

# Deactivating the Buttons on the Unit

## *(Child Lock)*

You can deactivate the buttons on the unit (except for **I/⏻**) for preventing misoperation, such as child mischief (child lock function).

**Press ■ on the unit for more than 5 seconds.**

“LOCKED” appears in the front panel display. The child lock function is activated and the buttons on the unit are locked. (You can operate the system by using the remote.)

To cancel, press ■ for more than 5 seconds so that “UNLOCK” appears in the front panel display.

### Note

- When you operate the buttons on the unit while the child lock function is on, “LOCKED” flashes in the front panel display.

---

# Controlling Your TV with the Supplied Remote

By adjusting the remote signal, you can control your TV with the supplied remote.

### Note

- When you replace the batteries of the remote, the code number may reset itself to the default (SONY) setting. Reset the appropriate code number.

## Preparing the remote for controlling the TV

**Press and hold TV **I/⏻** while entering your TV's manufacturer's code (see the table) using the number buttons. Then release TV **I/⏻**.**

If the setting is unsuccessful, the currently registered code is not changed. Re-enter the code number.

## Code numbers of controllable TVs

If more than one code number is listed, try entering them one at a time until you find the code that works with your TV.

Manufacturer	Code number
SONY	01 (default)
LG	02
PANASONIC	05
SAMSUNG	02, 06
SHARP	03
TOSHIBA	04
VIZIO	07

---

# Changing the Brightness of the Front Panel Display and Power Indicator

**Press DIMMER.**

Each time you press DIMMER, the brightness of the front panel display and power indicator is changed.

---

# Saving Power in Standby Mode

Check that the following settings are both made:

- [Control for HDMI] in [HDMI Settings] is set to [Off] (page 46).
- [Quick Start Mode] is set to [Off] (page 46).

# Browsing Websites

- 1 Prepare for Internet browsing.**  
Connect the system to a network (page 19).
- 2 Press HOME.**  
The home menu appears on the TV screen.
- 3 Press  $\leftarrow/\rightarrow$  to select [Network].**
- 4 Press  $\uparrow/\downarrow$  to select [Internet Browser], then press  $\oplus$ .**  
The [Internet Browser] display appears.

## Note

- Some websites may not display correctly, or not function.

## To enter a URL

Select [URL entry] from the options menu.  
Enter the URL using the software keyboard, then select [Enter].

## To set the default start page

While the page you want to set is displayed, select [Set as start page] from the options menu.

## To return to the previous page

Select [Previous page] from the options menu.  
When the previous page does not appear even if you select [Previous page], select [Window List] from the options menu and select the page you want to return to from the list.

## To quit Internet Browser

Press HOME.

# Internet Browser display

You can check website information by pressing DISPLAY. The display information differs depending on the website and page status.

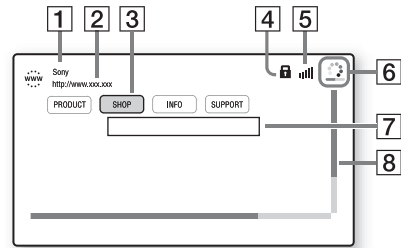

- 1** Page title
- 2** Page address
- 3** Cursor  
Move by pressing  $\leftarrow/\uparrow/\downarrow/\rightarrow$ . Place the cursor on the link you want to view, then press  $\oplus$ .  
The linked website is displayed.
- 4** SSL icon  
Appears when the linked URL is secured.
- 5** Signal strength indicator  
Appears when the system is connected to a wireless network.
- 6** Progress bar/Loading icon  
Appears when the page is being read, or during file download/transfer.
- 7** Text input field  
Press  $\oplus$ , then choose [Input] from the options menu to open the software keyboard.
- 8** Scroll bar  
Press  $\leftarrow/\uparrow/\downarrow/\rightarrow$  to move the page display left, up, down, or right.

# Available options

Various settings and operations are available by pressing OPTIONS.  
The available items differ depending on the situation.

Items	Details
[Browser Setup]	Displays the Internet Browser settings. <ul style="list-style-type: none"> <li>• [Zoom]: Increases or decreases the size of the displayed contents.</li> <li>• [JavaScript Setup]: Sets whether to enable or disable JavaScript.</li> <li>• [Cookie Setup]: Sets whether or not to accept browser cookies.</li> <li>• [SSL Alarm Display]: Sets whether to enable or disable SSL.</li> </ul>
[Input]	Displays the software keyboard to enter characters while browsing a website.
[Break]	Moves the cursor to the next line in the text input field.
[Delete]	Erases one character on the left side of the cursor during text input.
[Window List]	Displays a list of all currently opened websites. Allows you to return to a previously displayed website by selecting the window.
[Bookmark List]	Displays the bookmark list.
[URL entry]	Allows you to enter a URL when the software keyboard is displayed.
[Previous page]	Moves to a previously displayed page.
[Next page]	Moves to the previously displayed next page.
[Cancel loading]	Stops loading a page.
[Reload]	Reloads the same page.
[Add to Bookmark]	Adds the currently displayed website to the bookmark list.
[Set as start page]	Sets the currently displayed website as the default start page.
[Open in new window]	Opens a link in a new window.
[Character encoding]	Sets the character code.
[Display certificate]	Displays server certificates sent from pages that support SSL.

## Further Settings for the Wireless System

### Activating wireless transmission between specific units

#### [Secure Link]

You can specify the wireless connection to link the main unit to the surround amplifier using the Secure Link function.

This function can help prevent interference if you use multiple wireless products or your neighbors use wireless products.

- 1 Press HOME.**  
The home menu appears on the TV screen.
- 2 Press  $\leftrightarrow$  to select  [Setup].**
- 3 Press  $\updownarrow$  to select [System Settings], then press  $\oplus$ .**
- 4 Press  $\updownarrow$  to select [Wireless Sound Connection], then press  $\oplus$ .**  
The [Wireless Sound Connection] display appears.

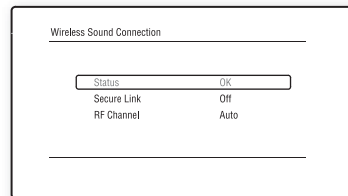

- 5 Press  $\updownarrow$  to select [Secure Link], then press  $\oplus$ .**
- 6 Press  $\updownarrow$  to select [On], then press  $\oplus$ .**
- 7 Press SECURE LINK on the rear of the surround amplifier.**

Proceed to the next Step within a few minutes.



- 8** Press **←/→** to select **[Start]**, then press **⊕**.

To return to the previous display, select **[Cancel]**.

- 9** After the message **[Secure Link setting is complete.]** appears, press **⊕**.

The surround amplifier is linked to the main unit and the **LINK/STANDBY** indicator turns orange.

If the message **[Cannot set Secure Link.]** appears, follow the on-screen messages.

## To cancel the Secure Link function

### For the main unit

Select **[Off]** on Step 6 above.

### For the surround amplifier

Press and hold **SECURE LINK** on the rear of the surround amplifier until the **LINK/STANDBY** indicator turns green or flashes green.

## If wireless transmission is unstable

### [RF Channel]

If you use multiple wireless systems, such as a wireless LAN (Local Area Network) or Bluetooth, the wireless signals may be unstable. In this case, the transmission may be improved by changing the following **[RF Channel]** setting.

- 1** Press **HOME**.  
The home menu appears on the TV screen.
- 2** Press **←/→** to select **🗑️ [Setup]**.
- 3** Press **↑/↓** to select **[System Settings]**, then press **⊕**.
- 4** Press **↑/↓** to select **[Wireless Sound Connection]**, then press **⊕**.  
The **[Wireless Sound Connection]** display appears.
- 5** Press **↑/↓** to select **[RF Channel]**, then press **⊕**.

- 6** Press **↑/↓** to select the desired setting, then press **⊕**.

- **[Auto]**: Normally select this. The system automatically selects the better channel for transmission.
- **[1], [2], [3]**: The system transmits sound by fixing the channel for transmitting. Select the channel with the better transmission.

### Note

The transmission may be improved by changing the transmission channel (frequency) of the other wireless system(s). For details, refer to the operating instructions of the other wireless system(s).

## Settings and Adjustments



# Using the Setup Display

You can make various adjustments to items such as picture and sound.









The default settings are underlined.



### Note

- Playback settings stored in the disc take priority over the Setup Display settings and not all the functions described may work.

- 1 Press HOME.**  
The home menu appears on the TV screen.
- 2 Press ←/→ to select  [Setup].**
- 3 Press ↑/↓ to select the setup category icon to change, then press .**

You can setup the following options.

Icon	Explanation
	<b>[Network Update] (page 42)</b> Updates the software of the system.
	<b>[Screen Settings] (page 43)</b> Makes the screen settings according to the type of connecting jacks.
	<b>[Audio Settings] (page 44)</b> Makes the audio settings according to the type of connecting jacks.
	<b>[BD/DVD Viewing Settings] (page 45)</b> Makes detailed settings for BD/DVD playback.
	<b>[Parental Control Settings] (page 45)</b> Makes detailed settings for the Parental Control function.
	<b>[Music Settings] (page 46)</b> Makes detailed settings for Super Audio CD playback.
	<b>[System Settings] (page 46)</b> Makes the system-related settings.
	<b>[External Input Settings] (page 47)</b> Sets the input skip setting for each external input.

Icon	Explanation
	<b>[Network Settings] (page 47)</b> Makes detailed settings for Internet and network.
	<b>[Easy Setup] (page 48)</b> Re-runs the Easy Setup to make the basic settings.
	<b>[Resetting] (page 48)</b> Resets the system to the factory settings.

## [Network Update]

For information about update functions, refer to the following website:

<http://www.sony.com/blurrayhtsupport/>

During a software update, “UPDATING” appears in the front panel display. After the update completes, the main unit automatically turns off. Please wait for the software update to complete; do not turn the main unit on or off, or operate the main unit or TV.



# Screen Settings

## ■ [3D Output Setting]

[Auto]: Normally select this.

[Off]: Select this to display all contents in 2D.

### Note

- 3D video from the HDMI (IN 1) or HDMI (IN 2) jack is output regardless of this setting.

## ■ [TV Screen Size Setting for 3D]

Sets the screen size of your 3D compatible TV.

### Note

- This setting does not apply to 3D video from the HDMI (IN 1) or HDMI (IN 2) jack.

## ■ [TV Type]

[16:9]: Select this when connecting to a wide-screen TV or a TV with a wide-mode function.

[4:3]: Select this when connecting to a 4:3 screen TV without a wide-mode function.

## ■ [Screen Format]

[Full]: Select this when connecting to a TV with a wide-mode function. Displays a 4:3 screen picture in 16:9 aspect ratio even on a wide-screen TV.

[Normal]: Changes the picture size to fit the screen size with the original picture aspect ratio.

## ■ [DVD Aspect Ratio]

[Letter Box]: Displays a wide picture with black bands on the top and bottom.



[Pan & Scan]: Displays a full-height picture on the entire screen, with trimmed sides.

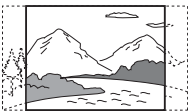

## ■ [Cinema Conversion Mode]

[Auto]: Normally select this. The unit automatically detects whether the material is video-based or film-based, and switches to the appropriate conversion method.

[Video]: The conversion method suited for video-based material will always be selected regardless of the material.

## ■ [Output Video Format]

[HDMI]: Normally select [Auto]. Select [Original Resolution] to output the resolution recorded on the disc. (When the resolution is lower than SD resolution, it is scaled up to SD resolution.)

[Video]: Automatically sets the lowest resolution.

## ■ [BD-ROM 24p Output]

[Auto]: Outputs 1920 × 1080p/24 Hz video signals only when connecting a 1080/24p-compatible TV using the HDMI (OUT) jack.

[On]: Select this when your TV is compatible with 1080/24p video signals.

[Off]: Select this when your TV is not compatible with 1080/24p video signals.

## ■ [DVD-ROM 24p Output]

[Auto]: Outputs 1920 × 1080p/24 Hz video signals only when connecting a 1080/24p-compatible TV using the HDMI (OUT) jack.

[Off]: Select this when your TV is not compatible with 1080/24p video signals.

## ■ [YCbCr/RGB (HDMI)]

[Auto]: Automatically detects the type of external device, and switches to the matching color setting.

[YCbCr (4:2:2)]: Outputs YCbCr 4:2:2 video signals.

[YCbCr (4:4:4)]: Outputs YCbCr 4:4:4 video signals.

[RGB]: Select this when connecting to a device with an HDCP compliant DVI jack.

## ■ [HDMI Deep Color Output]

[Auto]: Normally select this.

[16bit], [12bit], [10bit]: Outputs 16bit/12bit/10bit video signals when the connected TV is compatible with Deep Color.

[Off]: Select this when the picture is unstable or colors appear unnatural.

---

### ■ [SBM] (Super Bit Mapping)

[On]: Smooths the gradation of video signals output from the HDMI (OUT) jack.

[Off]: Select this when outputting distorted video signals or unnatural color.

---

### ■ [Pause Mode] (BD/DVD VIDEO/DVD-R/DVD-RW only)

[Auto]: The picture, including subjects that move dynamically, is output with no jitter.

Normally select this position.

[Frame]: The picture, including subjects that do not move dynamically, is output in high resolution.



## [Audio Settings]

---

### ■ [BD Audio MIX Setting]

[On]: Outputs the audio obtained by mixing the interactive audio and secondary audio to the primary audio.

[Off]: Outputs the primary audio only.

---

### ■ [Audio DRC]

You can compress the dynamic range of the sound track.

[Auto]: Performs playback at the dynamic range specified by the disc (BD-ROM only).

[On]: The system reproduces the sound track with the kind of dynamic range that the recording engineer intended.

[Off]: No compression of dynamic range.

---

### ■ [Attenuate - AUDIO]

Distortion may occur when you listen to a component connected to the AUDIO (AUDIO IN L/R) jacks. You can prevent distortion by attenuating the input level on the unit.

[On]: Attenuates the input level. The output level will decrease at this setting.

[Off]: Normal input level.

---

### ■ [Audio Output]

You can select the output method where the audio signal is output.

[Speaker]: Outputs multi-channel sound from the system's speakers only.

[Speaker + HDMI]: Outputs multi-channel sound from the system's speakers and 2-channel linear PCM signals from the HDMI (OUT) jack.

[HDMI]: Outputs sound from the HDMI (OUT) jack only. Sound format depends on the connected component.

#### Note

- When [Control for HDMI] is set to [On] (page 46), [Audio Output] is set to [Speaker + HDMI] automatically and this setting cannot be changed.
- When [Audio Output] is set to [HDMI], the output signal format for the "TV" function is 2-channel linear PCM.

---

### ■ [Sound Effect]

You can set the system's sound effects (SOUND MODE setting (page 23)) on/off.

For a 2-channel source, you can select [Dolby Pro Logic], [DTS Neo:6 Cinema], or [DTS Neo:6 Music] to simulate surround sound.

[Sound Mode On]: Enables the surround effect of the sound mode (page 23). The sampling frequency upper limit is set to 48 kHz.

[Dolby Pro Logic]: The system simulates surround sound from 2-channel sources and outputs sound from all the 5.1 channel speakers (Dolby Pro Logic decoding).

[DTS Neo:6 Cinema]/[DTS Neo:6 Music]: The system simulates surround sound from 2-channel sources and produces 6.1 channel sound (DTS Neo:6 Cinema/DTS Neo:6 Music mode decoding).

[Off]: The sound effects are disabled. You can hear sound as it is recorded.

---

### ■ [Speaker Settings]

To obtain the best possible surround sound, set the speakers. For details, see "Setting the Speakers" (page 36).

---

**■ [Auto Calibration]**

You can calibrate the appropriate settings automatically. For details, see “Calibrating the Appropriate Speaker Settings Automatically” (page 35).

---

**[BD/DVD Viewing Settings]**

---

**■ [BD/DVD Menu Language]**

You can select the default menu language for BD-ROMs or DVD VIDEOS.

When you select [Select Language Code], the display for entering the language code appears. Enter the code for your language by referring to “Language Code List” (page 60).

---

**■ [Audio Language]**

You can select the default track language for BD-ROMs or DVD VIDEOS.

When you select [Original], the language given priority in the disc is selected.

When you select [Select Language Code], the display for entering the language code appears. Enter the code for your language by referring to “Language Code List” (page 60).

---

**■ [Subtitle Language]**

You can select the default subtitle language for BD-ROMs or DVD VIDEOS.

When you select [Select Language Code], the display for entering the language code appears. Enter the code for your language by referring to “Language Code List” (page 60).

---

**■ [BD Hybrid Disc Playback Layer]**

[BD]: Plays BD layer.

[DVD/CD]: Plays DVD or CD layer.

---

**■ [BD Internet Connection]**

[Allow]: Normally select this.

[Do not allow]: Prohibits Internet connection.

---

**[Parental Control Settings]**

---

**■ [Password]**

Set or change the password for the Parental Control function. A password allows you to set a restriction on BD-ROM, DVD VIDEO, or Internet video playback. If necessary, you can differentiate the restriction levels for BD-ROMs and DVD VIDEOS.

---

**■ [Parental Control Area Code]**

Playback of some BD-ROMs or DVD VIDEOS can be limited according to the geographic area. Scenes may be blocked or replaced with different scenes. Follow the on-screen instructions and enter your four-digit password.

---

**■ [BD Parental Control]/[DVD Parental Control]/[Internet Video Parental Control]**

By setting Parental Control, scenes can be blocked or replaced with different scenes.

Follow the on-screen instructions and enter your four-digit password.

---

**■ [Internet Video Unrated]**

[Allow]: Allows the playback of unrated Internet videos.

[Block]: Blocks the playback of unrated Internet videos.



## [Music Settings]

### ■ [Super Audio CD Playback Layer]

[Super Audio CD]: Plays the Super Audio CD layer.

[CD]: Plays the CD layer.

### ■ [Super Audio CD Playback Channel]

[DSD 2ch]: Plays the 2-channel area.

[DSD Multi]: Plays the multi-channel area.



## [System Settings]

### ■ [OSD Language]

You can select your language for the system on-screen displays.

### ■ [Wireless Sound Connection]

You can make further settings for the wireless system. For details, see “Further Settings for the Wireless System” (page 40).

Also, you can check the wireless transmission status. When wireless transmission is activated, [OK] appears to the right of [Status].

### ■ [Illumination/Display]

You can select the status of the soft-touch buttons (page 9) and front panel display (page 10).

[On]: The soft-touch buttons and the front panel display stay illuminated.

[Auto]: The soft-touch buttons and the front panel display turn off when the system is not being operated.

### ■ [HDMI Settings]

[Control for HDMI]

[On]: On. You can operate mutually between components that are connected with an HDMI cable.

[Off]: Off.

[Audio Return Channel]

This function is available when you connect the system to a TV’s HDMI IN jack that is compatible with the Audio Return Channel function.

[Auto]: The system can receive the digital audio signal of the TV automatically via an HDMI cable.

[Off]: Off.

#### Note

- This function is available only when [Control for HDMI] is set to [On].

### ■ [Quick Start Mode]

[On]: Shortens the startup time from standby mode. You can operate the system quickly after turning it on.

[Off]: The default setting.

### ■ [Power Save Drive]

[On]: Reduces power consumption when volume level is low.

[Off]: Normal status. The system can output sound volume.

### ■ [Auto Display]

[On]: Automatically displays information on the screen when changing the viewing titles, picture modes, audio signals, etc.

[Off]: Displays information only when you press DISPLAY.

### ■ [Screen Saver]

[On]: Turns on the screen saver function.

[Off]: Off.

### ■ [Software Update Notification]

[On]: Sets the system to inform you of newer software version information (page 42).

[Off]: Off.

### ■ [Gracenote Settings]

[Auto]: Automatically downloads disc information when you stop playback of the disc. To download, the system must be connected to the network.

[Manual]: Downloads disc information when [Video Search] or [Music Search] is selected.

---

### ■ [System Information]

You can display the system's software version information and the MAC address.

---

### ■ [Software License Information]

You can display the Software License Information.

---

---

## [External Input Settings]

The skip setting is a convenient feature that allows you to skip unused inputs when selecting a function.

---

### ■ [HDMI1]/[HDMI2]/[TV]/[AUDIO]

[Do not skip]: The system does not skip the selected function when selecting the function by pressing FUNCTION.

[Skip]: The system skips the selected function when selecting the function by pressing FUNCTION.

---

---

## [Network Settings]

---

### ■ [Internet Settings]

Connect the system to the network beforehand. For details, see "Step 3: Preparing for Network Connection" (page 19).

[Wired Setup]: Select this when you connect to a broadband router using a LAN cable.

[Wireless Setup(built-in)]: Select this when you use the wireless LAN that is built into the system for wireless network connection.

[View Network Status]: Displays the current network status.

#### **Tip**

- For further details, visit the following website and check the FAQ:  
<http://www.sony.com/blurrayhtsupport/>
- 

### ■ [Network Connection Diagnostics]

You can run the network diagnostic to check if the network connection has been made properly.

---

### ■ [Connection Server Settings]

Sets whether or not to display the connected DLNA server.

---

### ■ [Renderer Options]

[Auto Access Permission]: Sets whether or not to allow automatic access from a newly detected DLNA controller.

[Smart Select]: Allows a Sony DLNA controller to find the system as the target component to operate by using the infrared ray. You can set this function to on or off.

[Renderer Name]: Displays the system's name as it is listed on other DLNA devices on the network.

---

### ■ [Renderer Access Control]

Sets whether or not to accept commands from DLNA controllers.

---

### ■ [PARTY Auto Start]

[On]: Starts a PARTY or joins an existing PARTY at the request of a networked device

---

compatible with the PARTY STREAMING function.

[Off]: Off.

---

### ■ [Media Remote Device Registration]

Registers your “Media Remote” device.

---

### ■ [Registered Media Remote Devices]

Displays a list of your registered “Media Remote” devices.

---

### ■ [Remote Start]

[On]: Permits turning on the system from the “Media Remote” device.

[Off]: Off.

---



## 1·2·3 [Easy Setup]

---

### ■ [Easy Initial Settings]

Runs [Easy Initial Settings] to make the basic settings. Follow the on-screen instructions.

---

### ■ [Easy Network Settings]

Runs [Easy Network Settings] to make the basic network settings. Follow the on-screen instructions.

---



## [Resetting]

---

### ■ [Reset to Factory Default Settings]

You can reset the system settings to the factory default by selecting the group of settings. All the settings within the group will be reset.

---

### ■ [Initialize Personal Information]

You can erase your personal information stored in the system.



# Precautions

### On safety

- To prevent fire or shock hazard, do not place objects filled with liquids, such as vases, on the system, or place the system near water, such as near a bathtub or shower room. Should any solid object or liquid fall into the cabinet, unplug the system and have it checked by qualified personnel before operating it any further.
- Do not touch the AC power cord (mains lead) with wet hands. Doing so may cause an electric shock.

### On power sources

- Unplug the unit from the wall outlet (mains) if you do not intend to use it for an extended period of time. To disconnect the cord, pull it out by the plug, never by the cord.

### On placement

- Place the system in a location with adequate ventilation to prevent heat build-up in the system.
- At high volume, over long periods of time, the cabinet becomes hot to the touch. This is not a malfunction. However, touching the cabinet should be avoided. Do not place the system in a confined space where ventilation is poor as this may cause overheating.
- Do not block the ventilation slots by putting anything on the system. The system is equipped with a high power amplifier. If the ventilation slots are blocked, the system can overheat and malfunction.
- Do not place the system on surfaces (rugs, blankets, etc.) or near materials (curtains, draperies) that may block the ventilation slots.
- Do not install the system in a confined space, such as a bookshelf or similar unit.
- Do not install the system near heat sources such as radiators, air ducts, or in a place subject to direct sunlight, excessive dust, mechanical vibration, or shock.
- Do not install the system in an inclined position. It is designed to be operated in a horizontal position only.
- Keep the system and discs away from components with strong magnets, such as microwave ovens, or large loudspeakers.
- Do not place heavy objects on the system.
- Do not place metal objects in front of the front panel. They may limit reception of radio waves.

- Do not place the system in a place where medical equipment is in use. It may cause a malfunction of medical equipment.
- If you use a pacemaker or other medical device, consult your physician or the manufacturer of your medical device before using the wireless LAN function.

### On operation

- If the system is brought directly from a cold to a warm location, or is placed in a very damp room, moisture may condense on the lenses inside the unit. Should this occur, the system may not operate properly. In this case, remove the disc and leave the system turned on for about half an hour until the moisture evaporates.
- When you move the system, take out any disc. If you do not, the disc may be damaged.
- If anything falls into the cabinet, unplug the unit and have it checked by qualified personnel before operating it any further.

### On adjusting volume

- Do not turn up the volume while listening to a section with very low level inputs or no audio signals. If you do, the speakers may be damaged when a peak level section is suddenly played.

### On cleaning

- Clean the cabinet, panel, and controls with a soft cloth slightly moistened with a mild detergent solution. Do not use any type of abrasive pad, scouring powder or solvent such as alcohol or benzine. If you have any questions or problems concerning your system, please consult your nearest Sony dealer.

### On cleaning discs, disc/lens cleaners

- **Do not use cleaning discs or disc/lens cleaners (including wet or spray types). These may cause the apparatus to malfunction.**

### On replacement of parts

- In the events that this system is repaired, repaired parts may be collected for reuse or recycling purposes.

### On your TV's color

- If the speakers should cause the TV screen to have color irregularity, turn off the TV then turn it on after 15 to 30 minutes. If color irregularity should persist, place the speakers further away from the TV set.

### IMPORTANT NOTICE

Caution: This system is capable of holding a still video image or on-screen display image on your television screen indefinitely. If you leave the still video image or on-screen display image displayed on your TV for an extended period of time you risk permanent damage to your television screen. Projection televisions are especially susceptible to this.

### On moving the system

- Before moving the system, make sure that there is no disc inserted, and remove the AC power cord (mains lead) from the wall outlet (mains).

## Notes about Discs

### On handling discs

- To keep the disc clean, handle the disc by its edge. Do not touch the surface.
- Do not stick paper or tape on the disc.



- Do not expose the disc to direct sunlight or heat sources such as hot air ducts, or leave it in a car parked in direct sunlight as the temperature may rise considerably inside the car.
- After playing, store the disc in its case.

### On cleaning

- Before playing, clean the disc with a cleaning cloth.

Wipe the disc from the center out.



- Do not use solvents such as benzine, thinner, commercially available cleaners, or anti-static spray intended for vinyl LPs.

This system can only play a standard circular disc. Using neither standard nor circular discs (e.g., card, heart, or star shape) may cause a malfunction.

Do not use a disc that has a commercially available accessory attached, such as a label or ring.

# Troubleshooting

If you experience any of the following difficulties while using the system, use this troubleshooting guide to help remedy the problem before requesting repairs. Should any problem persist, consult your nearest Sony dealer.

Note that if service personnel changes some parts during repair, these parts may be retained. In the event of a problem with the wireless sound function, have a Sony dealer check the entire system together (main unit and surround amplifier).

## General

### The power does not turn on.

→ Check that the AC power cord (mains lead) is connected securely.



### The remote does not function.

→ The distance between the remote and the unit is too far.

→ The batteries in the remote are weak.

### The disc does not eject and you cannot remove the disc even after you press .

→ Try the following:

- ① Press and hold  and  on the unit for more than 5 seconds to eject the disc.
- ② Remove the disc.
- ③ Disconnect the AC power cord (mains lead) from the wall outlet (mains), then reconnect after several minutes.

### The system does not work normally.

→ Disconnect the AC power cord (mains lead) from the wall outlet (mains), then reconnect after several minutes.

## Messages

**[A new software version is available. Please go to the “Setup” section of the menu and select “Network Update” to perform the update.] appears on the TV screen.**

→ See [Network Update] (page 42) to update the system to a newer software version.

**“PROTECT” and “PUSH PWR” appear alternately in the front panel display.**

→ Press  to turn off the system, and check the following items after “STANDBY” disappears.

- Are the + and – speaker cords short-circuited?
- Are you using only the specified speakers?
- Is anything blocking the ventilation holes of the system?
- After checking the above items and fixing any problems, turn on the system. If the cause of the problem cannot be found even after checking all the above items, consult your nearest Sony dealer.

**“LOCKED” appears in the front panel display.**

→ Set the child lock function to off (page 38).

**“DEMO. LOCK” appears in the front panel display.**

→ Contact your nearest Sony dealer or local authorized Sony service facility.

**“Exxxx” appears in the front panel display.**

→ Contact your nearest Sony dealer or local authorized Sony service facility and give the error code.

 **appears without any messages on the entire TV screen.**

→ Contact your nearest Sony dealer or local authorized Sony service facility.

## Picture

**There is no picture.**

→ Check the output method on your system (page 16).

### **There is no picture when you make an HDMI cable connection.**

- The unit is connected to an input device that is not HDCP (High-bandwidth Digital Content Protection) compliant (“HDMI” on the front panel does not light up) (page 16).

### **3D images from the HDMI (IN 1) or HDMI (IN 2) jack do not appear on the TV screen.**

- Depending on the TV or video component, 3D images may not appear.

### **No picture appears when the video output resolution selected in [Output Video Format] is incorrect.**

- Press and hold **▶** and **VOL -** on the unit for more than 5 seconds to reset the video output resolution to the lowest resolution.

### **The dark area of the picture is too dark/the bright area is too bright or unnatural.**

- Set [Picture Quality Mode] to [Standard] (default) (page 31).

### **The picture is not output correctly.**

- Check the [Output Video Format] settings in [Screen Settings] (page 43).
- If the analog and digital signals are output at the same time, set [BD-ROM 24p Output] or [DVD-ROM 24p Output] in [Screen Settings] to [Off] (page 43).
- For BD-ROMs, check the [BD-ROM 24p Output] settings in [Screen Settings] (page 43).

### **Picture noise appears.**

- Clean the disc.
- If the picture output from your system goes through your VCR to get to your TV, the copy-protection signal applied to some BD/DVD programs could affect picture quality. If you still experience problems even when you connect your unit directly to your TV, try connecting your unit to the other input jacks.

### **An image is not displayed on the entire TV screen.**

- Check the setting of [TV Type] in [Screen Settings](page 43).
- The aspect ratio on the disc is fixed.

### **Color irregularity occurs on the TV screen.**

- If the speakers are used with a CRT-based TV or projector, install the speakers at least 1.0 ft (0.3 meters) from the TV set.
- If the color irregularity persists, turn off the TV set once, then turn it on after 15 to 30 minutes.
- Make sure that no magnetic object (magnetic latch on a TV stand, health care device, toy, etc.) is placed near the speakers.

### **There is no picture after playing a video/photo file on the iPod/iPhone.**

- Select the input on your TV for this system.

## **Sound**

### **There is no sound.**

- The speaker cords are not connected securely.
- Check the speaker settings (page 36).

### **The Super Audio CD sound of a component that is connected to the HDMI (IN 1) or HDMI (IN 2) jack is not output.**

- HDMI (IN 1) and HDMI (IN 2) does not accept an audio format that contains copy protection. Connect the analog audio output of the component to the AUDIO (AUDIO IN L/R) jacks of the unit.

### **There is no sound from the TV via the HDMI (OUT) jack when using the Audio Return Channel function.**

- Set [Control for HDMI] in [HDMI Settings] of [System Settings] to [On] (page 46). Also, set [Audio Return Channel] in [HDMI Settings] of [System Settings] to [Auto] (page 46).
- Make sure that your TV is compatible with the Audio Return Channel function.
- Make sure that an HDMI cable is connected to a jack on your TV that is compatible with the Audio Return Channel function.

### **The system does not output sound of TV programs correctly when connected to a set-top box.**

- Set [Audio Return Channel] in [HDMI Settings] of [System Settings] to [Off] (page 46).
- Check the connections (page 17).

**Severe hum or noise is heard.**

- Move your TV away from the audio components.
- Clean the disc.

**The sound loses stereo effect when you play a CD.**

- Select stereo sound by pressing AUDIO (page 33).

**The sound comes from the center speaker only.**

- Depending on the disc, the sound may come from the center speaker only.

**No sound or only a very low-level sound is heard from the surround speakers.**

- Check the speaker connections and settings (pages 14, 36).
- Check the sound mode setting (page 23).
- Depending on the source, the effect of the surround speakers may be less noticeable.
- A 2-channel source is being played.

**Distortion occurs in the sound of a connected component.**

- Reduce the input level for the connected component by setting [Attenuate - AUDIO] (page 44).

**Wireless sound****Wireless transmission is not activated or there is no sound from the surround speakers.**

- Check the status of the LINK/STANDBY indicator on the surround amplifier.
  - Turns off.
    - Check that the AC power cord (mains lead) of the surround amplifier is connected securely.
    - Turn the surround amplifier on by pressing **I/⏻** on the surround amplifier.
  - Flashes green quickly.
    - ① Press **I/⏻** on the surround amplifier.
    - ② Insert the wireless transceiver into the surround amplifier correctly.
    - ③ Press **I/⏻** on the surround amplifier.
  - Flashes red.
    - Press **I/⏻** to turn off the surround amplifier, and check the following items.

- ① Are the + and – speaker cords short-circuited?

- ② Is anything blocking the ventilation holes of the surround amplifier?

After checking the above items and fixing any problems, turn on the surround amplifier. If the cause of the problem cannot be found even after checking all the above items, consult your nearest Sony dealer.

- Flashes green or orange slowly or turns red.
  - Make sure that the wireless transceiver is inserted correctly into the main unit.
  - Make the [Secure Link] setting again (page 40).
  - Sound transmission is poor. Move the surround amplifier so that the LINK/STANDBY indicator turns green or orange.
  - Move the system away from other wireless devices.
  - Avoid using any other wireless devices.
- Turns green or orange.
  - Check the speaker connections and settings.

**Noise is heard from surround speakers or sound from the surround speakers skips.**

- Wireless transmission is unstable. Change the [RF Channel] setting in [Wireless Sound Connection] (page 41).
- Install the unit and surround amplifier closer to each other.
- Do not install the unit and surround amplifier in a closed rack, on a metal rack, or under a table.

**Tuner****Radio stations cannot be tuned in.**

- Check that the antenna (aerial) is connected securely. Adjust the antenna (aerial) or connect an external antenna (aerial) if necessary.
- The signal strength of the stations is too weak (when tuning in with automatic tuning). Use manual tuning.

## Playback

### The disc does not play.

- The region code on the BD/DVD does not match the system.
- Moisture has condensed inside the unit and may cause damage to the lenses. Remove the disc and leave the unit turned on for about half an hour.
- The system cannot play a recorded disc that is not correctly finalized (page 55).

### File names are not displayed correctly.

- The system can only display ISO 8859-1 compliant character formats. Other character formats may be displayed differently.
- Depending on the writing software used, the input characters may be displayed differently.

### A disc does not start playing from the beginning.

- Resume play has been selected. Press **OPTIONS** and select [Play from beginning], then press **⊕**.

### Playback does not start from the resume point where you last stopped playing.

- The resume point may be cleared from memory depending on the disc when
  - you open the disc tray.
  - you disconnect the USB device.
  - you play other content.
  - you turn off the unit.

### The language for the soundtrack/subtitle or angles cannot be changed.

- Try using the BD's or DVD's menu.
- Multi-lingual tracks/subtitles or multi-angles are not recorded on the BD or DVD being played.

### Bonus contents or other data that are contained in a BD-ROM cannot be played.

- Try the following:
  - ① Remove the disc.
  - ② Turn the system off.
  - ③ Remove and reconnect the USB device (page 26).
  - ④ Turn the system on.
  - ⑤ Insert the BD-ROM with BONUSVIEW/BD-LIVE.

## USB device

### The USB device is not recognized.

- Try the following:
  - ① Turn the system off.
  - ② Remove and reconnect the USB device.
  - ③ Turn the system on.
- Make sure that the USB device is securely connected to the **↔** (USB) port.
- Check if the USB device or a cable is damaged.
- Check if the USB device is on.
- If the USB device is connected via a USB hub, disconnect it and connect the USB device directly to the unit.

## BRAVIA Internet Video

### The picture/sound is poor/certain programs display with a loss of detail, especially during fast-motion or dark scenes.

- Picture/sound quality may be poor depending on Internet content providers.
- Picture/sound quality may be improved by changing the connection speed. Sony recommends a connection speed of at least 2.5 Mbps for standard-definition video and 10 Mbps for high-definition video.
- Not all videos contain sound.

### The picture is small.

- Press **↑** to zoom in.

## “BRAVIA” Sync ([Control for HDMI])

### The [Control for HDMI] function does not work (“BRAVIA” Sync).

- Check that [Control for HDMI] is set to [On] (page 46).
- If you change the HDMI connection, turn the system off and on again.
- If power failure occurs, set [Control for HDMI] to [Off], then set [Control for HDMI] to [On] (page 46).
- Check the following and refer to the operating instructions supplied with the component.
  - The connected component is compatible with the [Control for HDMI] function.

- The connected component's setting for the [Control for HDMI] function is correct.

## Network connection

### The system cannot connect to the network.

- Check the network connection (page 19) and the network settings (page 47).

## Wireless LAN connection

### You cannot connect your PC to the Internet after [Wi-Fi Protected Setup (WPS)] is performed.

- The wireless settings of the router may change automatically if you use the Wi-Fi Protected Setup function before adjusting the settings of the router. In this case, change the wireless settings of your PC accordingly.

### The system cannot connect to the network or the network connection is unstable.

- Check if the wireless LAN router is on.
- Check the network connection (page 19) and the network settings (page 47).
- Depending on the usage environment, including the wall material, radio wave reception conditions, or obstacles between the system (or USB wireless LAN adapter) and the wireless LAN router, the possible communication distance may be shortened. Move the system and the wireless LAN router closer to each other.
- Devices that use a 2.4 GHz frequency band, such as a microwave, Bluetooth, or digital cordless device, may interrupt communication. Move the unit away from such devices, or turn off such devices.

### The desired wireless router is not shown in the wireless network list.

- Press RETURN to return to the previous screen, and try [Wireless Setup(built-in)]/[USB Wireless Setup] again. If the desired wireless router is still not detected, select [Manual registration].

## Playable Discs

<b>Blu-ray Disc</b>	BD-ROM <sup>1)</sup> BD-R/BD-RE <sup>2)</sup>
<b>DVD<sup>3)</sup></b>	DVD-ROM DVD-R/DVD-RW DVD+R/DVD+RW
<b>CD<sup>3)</sup></b>	CD-DA (Music CD) CD-ROM CD-R/CD-RW Super Audio CD

<sup>1)</sup>Since Blu-ray Disc specifications are new and evolving, some discs may not be playable depending on the disc type and version. Also, the audio output differs depending on the source, connected output jack, and selected audio settings.

<sup>2)</sup>BD-RE: Ver.2.1  
BD-R: Ver.1.1, 1.2, 1.3 including organic pigment type BD-R (LTH type)  
BD-Rs recorded on a PC cannot be played if postscripts are recordable.

<sup>3)</sup>A CD or DVD disc will not play if it has not been correctly finalized. For more information, refer to the operating instructions supplied with the recording device.

### Discs that cannot be played

- BDs with cartridge
- BDXLs
- DVD-RAMs
- HD DVDs
- DVD Audio discs
- PHOTO CDs
- Data part of CD-Extras
- Super VCDs
- Audio material side on DualDiscs
- For U.S. and Canada models: A disc recorded in a color system other than NTSC, such as PAL  
(This system conforms to the NTSC color system.)

### Notes on discs

This product is designed to play back discs that conform to the Compact Disc (CD) standard. DualDiscs and some music discs encoded with copyright protection technologies do not conform to the Compact Disc (CD) standard.

Therefore, these discs may not be compatible with this product.

### Note on playback operations of a BD/DVD

Some playback operations of a BD/DVD may be intentionally set by software producers. Since this system plays a BD/DVD according to the disc contents the software producers designed, some playback features may not be available.

### Note about double-layer BDs/DVDs

The playback picture and sound may be momentarily interrupted when the layers switch.

### Region code (BD-ROM/DVD VIDEO only)

Your system has a region code printed on the bottom of the unit and will only play a BD-ROM/DVD VIDEO (playback only) labeled with identical region codes or .

## Playable Types of Files

### Video

File format	Extensions
MPEG-1 Video/PS <sup>1)5)</sup>	“.mpg,” “.mpeg,” “.m2ts,”
MPEG-2 Video/PS, TS <sup>1)6)</sup>	“.mts”
Xvid	“.avi”
MPEG4/AVC <sup>1)5)</sup>	“.mkv,” “.mp4,” “.m4v,” “.m2ts,” “.mts”
WMV9 <sup>1)5)</sup>	“.wmv,” “.asf”
AVCHD <sup>2)</sup>	3)5)

### Music

File format	Extensions
MP3 (MPEG-1 Audio Layer III)	“.mp3”
AAC/HE-AAC <sup>1)4)5)</sup>	“.m4a”
WMA9 Standard <sup>1)4)</sup>	“.wma”
LPCM	“.wav”

### Photo

File format	Extensions
JPEG	“.jpg,” “.jpeg”
GIF <sup>7)</sup>	“.gif”
PNG <sup>7)</sup>	“.png”
MPO <sup>8)</sup>	“.mpo”

<sup>1)</sup>The system does not play files encoded with DRM.

<sup>2)</sup>AVCHD Ver.2.0 (AVCHD 3D/Progressive) compatible.

<sup>3)</sup>The system plays AVCHD-format files that are recorded via a digital video camera, etc. To watch AVCHD-format files, the disc with AVCHD-format files on it must be finalized.

<sup>4)</sup>The system does not play files encoded with Lossless, etc.

<sup>5)</sup>The system does not play these files via the DLNA function.

<sup>6)</sup>The system plays SD resolution only via the DLNA function.

<sup>7)</sup>The system does not play animated PNG or animated GIF files.

<sup>8)</sup>For MPO files other than 3D, the key image or the first image is displayed.



**Note**

- Some files may not play depending on the file format, the file encoding, the recording condition, or DLNA server condition.
- Some files edited on a PC may not play.
- The system can recognize the following files or folders in BDs, DVDs, CDs and USB devices:
  - up to folders in the 9th layer, including the root folder
  - up to 500 files/folders in a single layer
- The system can recognize the following files or folders stored in the DLNA server:
  - up to folders in the 19th layer
  - up to 999 files/folders in a single layer
- Some USB devices may not work with this system.
- The system can recognize Mass Storage Class (MSC) devices (such as flash memory or an HDD), Still Image Capture Devices (SICDs), and 101-key keyboards.
- To avoid data corruption or damage to USB memory or other devices, turn the system off before connecting or removing USB memory or other devices.
- The system may not play high bit rate video files from a DATA CD smoothly. It is recommended to play high bit rate video files using a DATA DVD or DATA BD.

## Supported Audio Formats

Audio formats supported by this system are as follows.

Format	Function		
	“BD/DVD”	“HDMI1” “HDMI2”	“TV” (DIGITAL IN)
<b>LPCM 2ch</b>	○	○	○
<b>LPCM 5.1ch</b>	○	○	–
<b>LPCM 7.1ch</b>	○	–	–
<b>Dolby Digital</b>	○	○	○
<b>Dolby TrueHD, Dolby Digital Plus</b>	○	–	–
<b>DTS</b>	○	○	○
<b>DTS-ES Discrete 6.1, DTS-ES Matrix 6.1</b>	–	–	–
<b>DTS96/24</b>	○	–	–
<b>DTS-HD High Resolution Audio</b>	○	–	–
<b>DTS-HD Master Audio</b>	○	–	–

○: Supported format.

–: Unsupported format.

**Note**

- HDMI (IN 1) and HDMI (IN 2) do not input sound in the case of an audio format that contains copy protections such as Super Audio CD or DVD-Audio.
- For LPCM 2ch format, the supported sampling frequency of the digital signal is up to 96 kHz when using the “HDMI1” or “HDMI2” function, and 48 kHz when using the “TV” function.
- For LPCM 5.1ch format, the supported sampling frequency of the digital signal is up to 48 kHz when using the “HDMI1” or “HDMI2” function.

# Specifications

## Amplifier Section

AUDIO POWER SPECIFICATIONS  
POWER OUTPUT AND TOTAL HARMONIC  
DISTORTION:  
(FTC)

Front L + Front R: With 3 ohms loads, both channels driven, from 180 Hz - 20 kHz; rated 50 watts per channel minimum RMS power, with no more than 1% total harmonic distortion from 250 milli watts to rated output.

POWER OUTPUT (reference)

Front L/Front R: 125 W (per channel at 3 ohms, 1 kHz)

Center: 250 W (at 6 ohms, 1 kHz)

Subwoofer: 250 W (at 6 ohms, 80 Hz)

Inputs (Analog)

AUDIO (AUDIO IN) Sensitivity: 3.0 V/1.0 V

Inputs (Digital)

TV (Audio Return Channel/OPTICAL)

Supported formats: LPCM 2CH (up to 48 kHz), Dolby Digital, DTS

HDMI (IN 1)/HDMI (IN 2)

Supported formats: LPCM 5.1CH (up to 48 kHz), LPCM 2CH (up to 96 kHz), Dolby Digital, DTS

## Video Section

Outputs VIDEO: 1 Vp-p 75 ohms

## HDMI Section

Connector Type A (19pin)

## BD/DVD/Super Audio CD/CD System

Signal format system NTSC

## USB Section

↔ USB 1/2 port: Type A (For connecting USB memory, memory card reader, digital still camera, and digital video camera)

## LAN Section

LAN (100) terminal 100BASE-TX Terminal

## Wireless LAN Section

### Blu-ray Disc/DVD receiver (HBD-N790W)

Standards Compliance IEEE 802.11 b/g/n

Frequency and Channel 2.4 GHz - 2.4835 GHz [CH1 -11]

## FM Tuner Section

System PLL quartz-locked digital synthesizer

Tuning range 87.5 MHz - 108.0 MHz (100 kHz step)

Antenna (aerial) FM wire antenna (aerial)

Antenna (aerial) terminals 75 ohms, unbalanced

## Speakers

### Front (SS-TSB112)

Dimensions (approx.) 98 mm × 318 mm × 103 mm (3 <sup>7</sup>/<sub>8</sub> in × 12 <sup>1</sup>/<sub>2</sub> in × 4 <sup>1</sup>/<sub>8</sub> in) (w/h/d)

Mass (approx.) 0.7 kg (1 lb 9 oz)

### Surround (SS-TSB111)

Dimensions (approx.) 98 mm × 255 mm × 91 mm (3 <sup>7</sup>/<sub>8</sub> in × 10 in × 3 <sup>5</sup>/<sub>8</sub> in) (w/h/d)

Mass (approx.) 0.6 kg (1 lb 6 oz)

### Center (SS-CTB111)

Dimensions (approx.) 331 mm × 59 mm × 57 mm (13 <sup>1</sup>/<sub>8</sub> in × 2 <sup>3</sup>/<sub>8</sub> in × 2 <sup>1</sup>/<sub>4</sub> in) (w/h/d)

Mass (approx.) 0.5 kg (1 lb 2 oz)

### Subwoofer (SS-WSB111)

Dimensions (approx.) 191 mm × 326 mm × 376 mm (7 <sup>1</sup>/<sub>2</sub> in × 12 <sup>3</sup>/<sub>4</sub> in × 14 <sup>3</sup>/<sub>4</sub> in) (w/h/d)

Mass (approx.) 5.6 kg (12 lb 6 oz)

## General

Power requirements 120 V AC, 60 Hz

Power consumption On: 115 W  
Standby: 0.3 W (at the Power Saving mode)

Dimensions (approx.) 460 mm × 74 mm × 226 mm (18 <sup>1</sup>/<sub>8</sub> in × 3 in × 9 in) (w/h/d) incl. projecting parts

460 mm × 74 mm × 239 mm (18 <sup>1</sup>/<sub>8</sub> in × 3 in × 9 <sup>1</sup>/<sub>2</sub> in) (w/h/d) (with the wireless transceiver inserted)

Mass (approx.) 3.6 kg (7 lb 15 oz)

**Surround amplifier (TA-SA300WR)**

Amplifier Section

U.S.models:

**AUDIO POWER SPECIFICATIONS****POWER OUTPUT AND TOTAL HARMONIC****DISTORTION:**

(FTC)                      With 3 ohms loads, both channels driven, from 180 - 20,000 Hz; rated 45 watts per channel minimum RMS power, with no more than 1% total harmonic distortion from 250 milli watts to rated output.

Other models:

**POWER OUTPUT (reference)**

Surround L/Surround R    125 W (per channel at 3 ohms, 1 kHz)

Rated impedance:        3 - 16  $\Omega$

Power requirements      120 V AC, 60 Hz

Power consumption      On: 50 W

Standby power consumption  
0.5 W (standby mode)  
0.2 W (turned off)

Dimensions (approx.)    206 mm  $\times$  60 mm  $\times$  236 mm (8 <sup>1</sup>/<sub>8</sub> in  $\times$  2 <sup>3</sup>/<sub>8</sub> in  $\times$  9 <sup>3</sup>/<sub>8</sub> in) (w/h/d) with the wireless receiver inserted

Mass (approx.)            1.3 kg (2 lb 14 oz)

**Wireless transceiver (EZW-RT50)**

Communication system    Wireless sound  
Specification version 1.0

Frequency band            5.736 GHz - 5.814 GHz

Modulation method      DSSS

Power requirements      DC 3.3 V, 300 mA

Dimensions (approx.)    30 mm  $\times$  9 mm  $\times$  60 mm (1 <sup>3</sup>/<sub>16</sub> in  $\times$  <sup>3</sup>/<sub>8</sub> in  $\times$  2 <sup>3</sup>/<sub>8</sub> in) (w/h/d)

Mass (approx.)            10 g (<sup>1</sup>/<sub>2</sub> oz)

Design and specifications are subject to change without notice.

- Standby power consumption 0.3W (Main Unit), 0.2W (Surround Amplifier).
- Over 85% power efficiency of amplifier block is achieved with the full digital amplifier, S-Master.

# Language Code List

The language spellings conform to the ISO 639: 1988 (E/F) standard.

Code Language	Code Language	Code Language	Code Language
1027 Afar	1183 Irish	1347 Maori	1507 Samoan
1028 Abkhazian	1186 Scots Gaelic	1349 Macedonian	1508 Shona
1032 Afrikaans	1194 Galician	1350 Malayalam	1509 Somali
1039 Amharic	1196 Guarani	1352 Mongolian	1511 Albanian
1044 Arabic	1203 Gujarati	1353 Moldavian	1512 Serbian
1045 Assamese	1209 Hausa	1356 Marathi	1513 Siswati
1051 Aymara	1217 Hindi	1357 Malay	1514 Sesotho
1052 Azerbaijani	1226 Croatian	1358 Maltese	1515 Sundanese
1053 Bashkir	1229 Hungarian	1363 Burmese	1516 Swedish
1057 Byelorussian	1233 Armenian	1365 Nauru	1517 Swahili
1059 Bulgarian	1235 Interlingua	1369 Nepali	1521 Tamil
1060 Bihari	1239 Interlingue	1376 Dutch	1525 Telugu
1061 Bislama	1245 Inupiak	1379 Norwegian	1527 Tajik
1066 Bengali;	1248 Indonesian	1393 Occitan	1528 Thai
Bangla	1253 Icelandic	1403 (Afan)Oromo	1529 Tigrinya
1067 Tibetan	1254 Italian	1408 Oriya	1531 Turkmen
1070 Breton	1257 Hebrew	1417 Punjabi	1532 Tagalog
1079 Catalan	1261 Japanese	1428 Polish	1534 Setswana
1093 Corsican	1269 Yiddish	1435 Pashto;	1535 Tonga
1097 Czech	1283 Javanese	Pushto	1538 Turkish
1103 Welsh	1287 Georgian	1436 Portuguese	1539 Tsonga
1105 Danish	1297 Kazakh	1463 Quechua	1540 Tatar
1109 German	1298 Greenlandic	1481 Rhaeto-	1543 Twi
1130 Bhutani	1299 Cambodian	Romance	1557 Ukrainian
1142 Greek	1300 Kannada	1482 Kirundi	1564 Urdu
1144 English	1301 Korean	1483 Romanian	1572 Uzbek
1145 Esperanto	1305 Kashmiri	1489 Russian	1581 Vietnamese
1149 Spanish	1307 Kurdish	1491 Kinyarwanda	1587 Volapük
1150 Estonian	1311 Kirghiz	1495 Sanskrit	1613 Wolof
1151 Basque	1313 Latin	1498 Sindhi	1632 Xhosa
1157 Persian	1326 Lingala	1501 Sangho	1665 Yoruba
1165 Finnish	1327 Laothian	1502 Serbo-Croatian	1684 Chinese
1166 Fiji	1332 Lithuanian	1503 Singhalese	1697 Zulu
1171 Faroese	1334 Latvian; Lettish	1505 Slovak	
1174 French	1345 Malagasy	1506 Slovenian	
1181 Frisian			1703 Not specified

## Parental Control/Area Code List

Code Area	Code Area	Code Area	Code Area
2044 Argentina	2109 Germany	2362 Mexico	2499 Sweden
2047 Australia	2200 Greece	2376 Netherlands	2086 Switzerland
2046 Austria	2219 Hong Kong	2390 New Zealand	2543 Taiwan
2057 Belgium	2248 India	2379 Norway	2528 Thailand
2070 Brazil	2238 Indonesia	2427 Pakistan	2184 United Kingdom
2090 Chile	2239 Ireland	2424 Philippines	
2092 China	2254 Italy	2428 Poland	
2093 Colombia	2276 Japan	2436 Portugal	
2115 Denmark	2304 Korea	2489 Russia	
2165 Finland	2333 Luxembourg	2501 Singapore	
2174 France	2363 Malaysia	2149 Spain	

# Index

## Numerics

3D 25  
3D Output Setting 43

## A

A/V SYNC 32  
Attenuate - AUDIO 44  
Audio DRC 44  
Audio Language 45  
Audio Output 44  
Audio Return Channel 46  
Audio Settings 44  
Auto Calibration 35, 45  
Auto Display 46

## B

BD Audio MIX Setting 44  
BD Hybrid Disc Playback  
  Layer 45  
BD Internet Connection 45  
BD Parental Control 45  
BD/DVD Menu Language 45  
BD/DVD Viewing Settings 45  
BD-LIVE 25  
BD-ROM 24p Output 43  
BONUSVIEW 25  
BRAVIA Sync 35

## C

CD 55  
Child Lock 38  
Cinema Conversion Mode 43  
Connection Server Settings 47  
Control for HDMI 35, 46

## D

D.C.A.C. (Digital Cinema Auto  
  Calibration) 35  
DLNA 28, 47  
Dolby Digital 33  
DTS 33  
DVD 55  
DVD Aspect Ratio 43  
DVD Parental Control 45  
DVD-ROM 24p Output 33

## E

Easy Initial Settings 48  
Easy Network Settings 48  
Easy Setup 22, 48  
External Input Settings 47

## F

FM Mode 34  
Front panel 9  
Front panel display 10

## G

Gracenote Settings 46

## H

HDMI  
  YCbCr/RGB (HDMI) 43  
HDMI Deep Color Output 43

## I

Illumination/Display 46  
Initialize Personal Information  
  48  
Internet content 28  
Internet Settings 47  
Internet Video Parental Control  
  45  
Internet Video Unrated 45

## L

Language Code List 60

## M

Media Remote Device  
  Registration 48  
Multiplex broadcast sound 33  
Music Settings 46

## N

Network Connection  
  Diagnostics 47  
Network Settings 47  
Network Update 42

## O

OSD Language 46  
Output Video Format 43

## P

Parental Control Area Code 45  
Parental Control Settings 45  
PARTY Auto Start 47  
Password 45  
Pause Mode 44  
Play information 26  
Playable discs 55  
Power Save Drive 46

## Q

Quick Start Mode 46

## R

Rear panel 10  
Region code 56  
Registered Media Remote  
  Devices 48  
Remote control 12  
Remote Start 48  
Renderer Access Control 47  
Renderer Options 47  
Reset to Factory Default  
  Settings 48  
Resetting 48

## S

SBM 44  
Screen Format 43  
Screen Saver 46  
Screen Settings 43  
SLEEP 37  
Slideshow 32  
Software License Information  
  47  
Sound Effect 44  
Speaker Settings 36, 44  
  Distance 36  
  Level 36  
Subtitle Language 45  
Super Audio CD Playback  
  Channel 46  
Super Audio CD Playback  
  Layer 46  
Surround amplifier 11  
System Information 47

## T

Test Tone 37  
TV Screen Size Setting for 3D  
  43  
TV Type 43

## U

Update 42  
USB 26

## **W**

WEP 20

Wireless Sound Connection 46

WPA2-PSK (AES) 20

WPA2-PSK (TKIP) 20

WPA-PSK (AES) 20

WPA-PSK (TKIP) 20



The software of this system may be updated in the future. To find out details on any available updates, please visit the following URL.

<http://www.sony.com/blurayhtsupport/>

**MAGNETIC  
FLUID  
SPEAKER**



<http://www.sony.net/>



\* 4 4 1 8 1 3 0 1 2 \* (2)